

SIEMENS

Ingenuity for life



Current version

SIRIUS modular system. The perfect combination

Switching, protecting, starting and monitoring
with the highly flexible modular system

[siemens.com/sirius-modular-system](https://www.siemens.com/sirius-modular-system)

Everything for the control cabinet: the SIRIUS modular system.

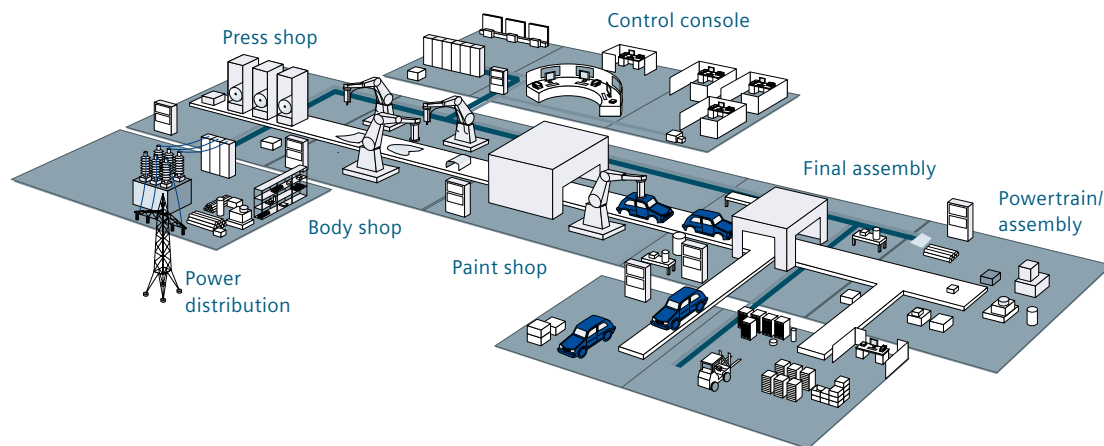

Processing, fitting, transporting. These and similar functions run on many automated production lines. With the extensive range of the SIRIUS modular system, you will find everything you need for switching, protecting, starting and monitoring motors.

Everything. Really easy. With SIRIUS.

Contents

| | |
|--|----|
| The components of the SIRIUS modular system | 4 |
| Combination of switching devices and protective devices | 8 |
| Convenient means of power supply and distribution | 9 |
| Electromechanical switching devices for fuseless assembly of load feeders up to 7.5 kW | 10 |
| Size S00 selection and ordering data: | |
| Motor starter protector, contactor with overload relay | 10 |
| Motor starter protector, contactor with current monitoring relay | 10 |
| Motor starter protector, soft starter with current monitoring relay | 13 |
| Motor starter protector, semiconductor contactor with current monitoring relay | 13 |
| Electromechanical switching devices for fuseless assembly of load feeders up to 18.5 kW | 16 |
| Size S0 selection and ordering data: | |
| Motor starter protector, contactor, overload relay | 17 |
| Motor starter protector, contactor with current monitoring relay | 17 |
| Motor starter protector, soft starter with current monitoring relay | 18 |
| Assembly of direct-on-line starters and reversing starters 37 kW | 21 |
| Size S2 selection and ordering data: | |
| Motor starter protector, contactor, overload relay | 21 |
| Motor starter protector, contactor with current monitoring relay | 21 |
| Assembly of direct-on-line starters and reversing starters up to 55 kW | 27 |
| Size S3 selection and ordering data | |
| Size S6, S10 and S12 | 31 |
| Selection and ordering data | |
| Fuseless load feeders | |
| Selection and ordering data: | |
| Direct-on-line starters | 34 |
| (fully pre-assembled load feeders, compact starters) | |
| Reversing starters | 35 |
| (fully pre-assembled load feeders, compact starters) | |
| Communication connection | 36 |
| (IO-Link/AS-Interface master, contactors, function modules for mounting on 3RT2 contactors and for connecting to the automation level, compact starters) | |
| Infeed systems | 39 |
| For compact starters, load feeders, 3-phase busbar, 8US busbar adapter | |
| Accessories | |
| Selection and ordering data: | |
| Motor starter protectors | 42 |
| Contactors | 43 |
| Overload relays, current monitoring relays | 48 |

Everything. Systematically. SIRIUS modular system.

Building control cabinets must be fast, simple, flexible and space-saving. How can all this be achieved? With the unique SIRIUS modular system that offers everything you will need for switching, protecting, and starting motors and systems. In other words, it provides a modular range of standard components up to 250 kW/ 400 V in only seven sizes, which are perfectly matched to one another, can be combined really easily, and largely use the same accessories. That's how easy industrial controls can be!



Continuous further development and regular innovations ensure that our customers are optimally equipped with SIRIUS and benefit from efficient solutions – now and in the future. All the components that make up the SIRIUS modular system are characterized by a space-saving design and a high degree of flexibility. Configuring, installing, wiring and maintenance are extremely easy and time-saving to perform. So no matter whether you want to configure load feeders with motor starter protectors, overload relays, contactors/solid-state contactors or soft starters, SIRIUS has just the product you will need for any application.

Thanks to the latest innovations to the modular system in sizes S00, S0, S2 and S3 up to 115 A, today's SIRIUS modular system shows even more functional diversity.

In addition to the basic components, the innovated SIRIUS modular system offers new, never-before-seen highlights:

- Feeder assemblies that can be plugged in completely without tools thanks to the consistent use of spring-loaded connections in sizes S00 and S0
- 2- and 3-phase 3RR2 monitoring relays for current monitoring for direct mounting on contactors (up to size S2)
- 3RA27 and 3RA28 function modules feature snap-on connection to contactors enabling the easiest possible assembly of direct-on-line starters, reversing starters, and star-delta (wye-delta) starting, and connection to the controller using less wiring via AS-Interface or IO-Link
- 3RB24 overload relay with communication capability, current value transmission, and control of the contactors via IO-Link
- One highlight of the SIRIUS devices is their IE3 and IE4 suitability, so that they are optimally equipped for conversion to the new IE3 and IE4 generation of motors

At a glance. The components of the SIRIUS modular system offer a host of benefits.

With its wide range of components, the SIRIUS modular system features the most diverse functions for use in the control cabinet, and offers a host of benefits in assembly and handling, in application monitoring, and also in controller interfacing, or when planning and configuring.



Assembly and handling:

Error prevention and reduced wiring effort – with maximum flexibility

- **Load feeders:** easy to implement up to 250 kW/400 V from standard devices
- **Modular design:** everything fits together and can be combined
- **Variants and sizes:** economical and flexible thanks to 7 compact sizes
- **Accessories:** low variance with uniform accessories
- **Configuration:** fast commissioning, short setting-up times, and simple wiring
- **Mounting:** permanently secure mounting, with screw terminals or simply by plugging in
- **Spring-loaded connection system:** quick and secure connection, vibration-proof, and maintenance-free
- **Reduced wiring:** significant reductions in cable connections thanks to plug-in design and IO-Link or AS-Interface

Applications at a glance:

Increased operational reliability and system availability

- **Maintenance:** extremely durable, low maintenance, and reliable
- **Application monitoring:** integrated extremely flexibly into the feeder – thanks to monitoring relays for current monitoring
- **IE3/IE4-ready:** With the SIRIUS modular system, we also offer you our familiar reliability when converting to IE3 and IE4 motors

Connection to the automation level:

Optimal integration into the automation environment

- **Communication:** standardized connection to AS-Interface, IO-Link and PROFIBUS DP possible

Planning and configuration:

Simplified system planning and documentation

- **Configuration:** easy and fast thanks to extensive CAx data provision
- **Service:** short delivery times even for spare parts thanks to global logistics network
- **Environment:** environmentally friendly production and materials, recyclable
- **Design:** clear, ergonomic design (winner of the iF Product Design Award)
- **Configurator:** for the simplest possible selection of products including accessories
- **Global use:** thanks to comprehensive approvals

Switching. Protecting. Starting. Monitoring.

The components of the SIRIUS modular system.



Much more than ON/OFF: SIRIUS 3RV motor starter protectors

The SIRIUS 3RV motor starter protectors are compact, current-limiting motor starter protectors. They ensure secure disconnection in case of a short-circuit and protect loads and the plant against overloads. They are also suited to functional switching of loads with a low frequency of operation, and for protective separation of the system from the power supply during maintenance work or modifications. For applications over 100 A, SENTRON 3VA circuit breakers are suitable.



Rugged and reliable: SIRIUS 3RT contactors

Thanks to their extreme ruggedness and outstanding contact reliability, our contactors switch supremely and reliably. In addition, they enable compact control cabinets with high packing density. With integrated ranges of accessories for sizes S00 to S3 as well as S6 to S12, individual function expansions can be implemented with no great effort. In sizes S00 to S3, the contactors even have the auxiliary switches integrated into the enclosure.



Tripping when things get serious: SIRIUS 3RU and 3RB overload relays

The overload relays of the SIRIUS family are available in thermal and electronic versions, and they are responsible for the inverse-time-delayed overload protection in the main circuit. The SIRIUS 3RB electronic overload relays ensure seamless protection for motors and systems from 0.1 A to 630 A. This current range can be covered with a minimum number of variants thanks to the large setting range.



Simplest possible application monitoring: SIRIUS 3RR2 current monitoring relays

The SIRIUS current monitoring relays monitor not so much the motor as the entire plant or driven process for overcurrent and undercurrent, wire break, or phase failure. Thus, load shedding or overload of an application, for example, is detected quickly and reported early. The 3RR2 monitoring relay for current monitoring is integrated directly into the load feeder in sizes S00, S0 and S2. Just attach it to the contactor, and click 'n' go.



Soft starting: SIRIUS 3RW soft starters

The SIRIUS 3RW soft starters offer a complete range that covers all basic performance applications of motor starting. Thus, the benefits of soft starting can be reaped in the most diverse applications up to 315 kW (at 400 V) for simple and economical implementation of optimum machine concepts. Economical and space-saving soft starting can be implemented up to 55 kW (at 400 V) with the compact 3RW30 with two-phase control. The 3RW40 also offers smooth ramp-down as well as integrated intrinsic device protection functions and motor protection functions. The 3RW50 also offer integration into the TIA Portal with optional communication modules and HMI modules. SIRIUS soft starters are available for line voltages up to 600 V – optionally also with thermistor motor protection evaluation.

Switching. Protecting. Starting. Monitoring. The components of the SIRIUS modular system.



Master the highest switching frequencies with confidence: SIRIUS 3RF solid-state contactors

SIRIUS solid-state contactors (size S0) for switching motors impress with their almost limitless service life – even under harsh conditions and at high switching frequencies. The three-phase solid-state contactors switch motors completely silently up to 7.5 kW.

A special reversing contactor version enables changing of the direction of rotation of motors up to 3 kW. The compact devices in widths of 45 or 90 mm can be combined with our motor starter protectors, current monitoring relays, or electronic overload relays. For fast and simple assembly of fuseless and fused motor feeders.



Compact switching and protecting: SIRIUS 3RA6 compact starters and 3RM1 motor starters

Equipped with the functions of a motor starter protector, a contactor, and an electronic overload relay, the 3RA6 compact starter as a direct-on-line or reversing starter up to 32 A offers maximum reliability with minimum variance. There is reduced wiring in the main circuit thanks to the ingeniously simple infeed system, including PE connection. Thanks to the optional AS-Interface or integrated IO-Link interface, 3RA6 compact starters are integrated into the Totally Integrated Automation design concept.

The 3RM1 direct-on-line or reversing starters up to 7 A reduce width even further to one half the previous size, and are thus master space-savers. Fail-safe design versions offer the greatest possible economizing on switching device deployment in safety-related applications.

SIRIUS contactor with spring-loaded terminals



Faster wiring thanks to integrated spring-loaded terminals

All products with 45-mm widths (S00- and S0-size series) in the main as well as auxiliary and control circuits are available with spring-loaded terminals in addition to the conventional screw terminals. This accelerates device connection, and offers maximum operational safety and reliability. The extremely simple wiring guarantees fast installation. Another advantage is that the gas-tight terminal connection is resistant to shaking and vibration. In addition, you benefit from maximum contact reliability – even under the harshest of conditions. There's no need to subsequently re-tighten the connection terminals (often the usual practice). One particular advantage is that the link modules for direct-on-line, reversing and star-delta (wye-delta) starting are also available with spring-loaded terminals. This enables you to install entire feeders entirely without tools. Spring-loaded terminals in the auxiliary circuit are optionally available in sizes S2 and S3.

SIRIUS contactor with screw terminals



Maximum flexibility when it comes to connections

All the components of the SIRIUS modular system are, of course, also available with screw terminals for special requirements such as mechanical engineering in the semiconductor industry. In sizes with design widths of 70 mm and larger (i.e. as of size S3), additional possible connection options are available such as for connecting cable terminal lugs to device connection bars, or connecting cables with large cross sections to box terminals.

Switching. Protecting. Starting. Monitoring. The components of the SIRIUS modular system.



Straight to the point:
the 3RA21 direct-on-line starter



Phases swapped:
the 3RA22 reversing starter



Two stages – one start:
the 3RA24 contactor
assembly for star-delta start

Ready for immediate use: pre-wired SIRIUS load feeders

Load feeders start loads with a combination of protection and switching functions. To reduce time and costs, and above all to minimize standstill times, we offer you a wide range of pre-wired starter solutions:

- Direct-on-line starters up to 30 kW and reversing starters up to 15 kW – the right starter combination for all motors – both for standard rail mounting and with 60 mm standard mounting rail adapters.
- Reversing contactor assemblies up to 55 kW – the appropriate combination for reversing duty – for fast rotation direction changes of motors
- Contactor assemblies for star-delta starting up to 90 kW – the solution for starting in stages for reducing start-up current peaks of motors.
- Soft starters – when soft starting and smooth ramp-down are required (in the case of the 3RW40 and 3RW50 even with integral overload protection)

An almost unlimited number of further tested combinations can be assembled easily from the individual components. The following manuals help you to make your selection, and they can be found in the Industry Online Support Portal at <http://support.automation.siemens.com>.

SIRIUS modular system

Configuration Manual "Configuring the SIRIUS Modular System – Selection Data for Fuseless and Fused Load Feeders"

Configuration instructions for IE3 and IE4 motors

Application manual for SIRIUS switching devices with IE3 and IE4 motors

Combination of switching devices and protective devices

| Electromechanical switching devices | Contactor and overload relay with fuse | Motor starter protector for motor protection and contactor | Motor starter protector for motor protection with relay function and contactor | Motor starter protector for starter protection, contactor and overload relay | Compact starter | Motor starter protector for motor protection, contactor and current monitoring relay | Motor starter protector for motor protection with relay function, contactor and current monitoring relay |
|-------------------------------------|--|--|--|--|-----------------|--|--|
| Short circuit | | | | | | | |
| Overload | | | | | | | |
| Switching | | | | | | | |
| Monitoring | | | | | | | |
| | Fused | Fuseless | | | | | |

| Solid-state switching devices | Mot. starter protector for motor protection, solid-state switching device (soft starter or solid-state contactor) and curr. monit. relay | Fuse and soft starter | Fuse, solid-state switching device and current monitoring relay | Motor starter protector for motor protection and solid-state switching device (soft starter or solid-state contactor) | Motor starter protector for motor protection, 3RM1 motor starter |
|-------------------------------|--|-----------------------|---|---|--|
| Short circuit | | | | | |
| Overload | | | | | |
| Switching | | | | | |
| Monitoring | | | | | |
| | Fuseless | Fused | | Fuseless | |

Convenient power infeed and distribution: SIRIUS 3RV29 and 3RA68 infeed systems.



Efficient and flexible power distribution

The components of the SIRIUS modular system can be wired extremely flexibly. For sizes S00 and S0, the simplest method is to connect the components via the associated SIRIUS 3RV29 infeed system in each case. Alongside this, the 3RA68 infeed system is available in conjunction with the 3RA6 compact starter – and both connection methods are available optionally for devices with screw and spring-loaded terminals. Individual motor starter protectors, complete load feeders, and compact starters are just clicked into the infeed systems. An entire feeder group is thus supplied with energy without any time-consuming wiring and with no risk of error – just click and go!

Alternatively, you can also use conventional wiring: by means of parallel wiring, 3-phase busbars or 8US busbar adapters

with which SIRIUS load feeders can be mounted directly on a 60 mm busbar system.

These diverse combination options provide you with the most effortless solution to implement your individual control cabinets – simply perfectly tailored to your application.

Assembly – Highlights

- Consistent use throughout by combining 3RV29 and 3RA68 modules
- New flexibility for installation and expansion
- More free space in the control cabinet – thanks to extremely compact design
- Infeed (3RA68) either on the left or right with conductor cross section up to 70 mm²
- Optional wiring channel between the feeders
- Additional integration of further 1-, 2- or 3-pole components via terminal block
- Maximum current carrying capacity of 100 A (3RA68)
- Integration of load feeders with screw and spring-loaded terminals
- High vibration resistance, especially for switching devices with spring-loaded terminals
- Time savings during installation thanks to simple plug-in design
- For 3RA68 infeed system also with PE connection option

Fuseless assembly

Assembly up to 7.5 kW (S00)

Motor starter protector for starter protection, contactor with overload relay

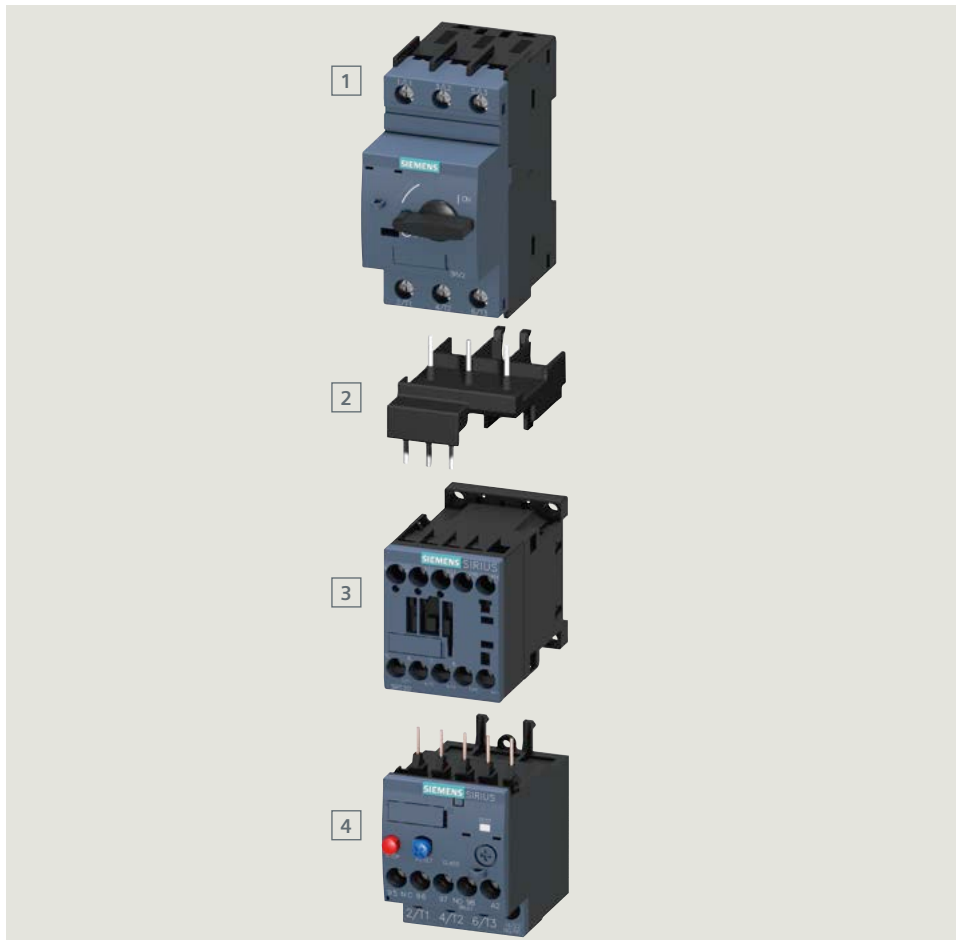

| Type | Screw terminals | Spring-loaded terminals |
|---------------------------|---------------------------------|------------------------------|
| 1 Motor starter protector | 3RV2311-□□□1□ | 3RV2311-□□□2□ |
| 2 Link module | 3RA1921-1DA00 | 3RA2911-2AA00 |
| 3 Contactor (AC/DC) | 3RT201□-1□□□□ | 3RT201□-2□□□□ |
| 4 Overload relay | 3RU2116-□□B0 or 3RB3□1□-□□B0 | 3RU2116-□□C0 3RB3016-□□E0 |

Motor starter protector for motor protection, contactor with current monitoring relay

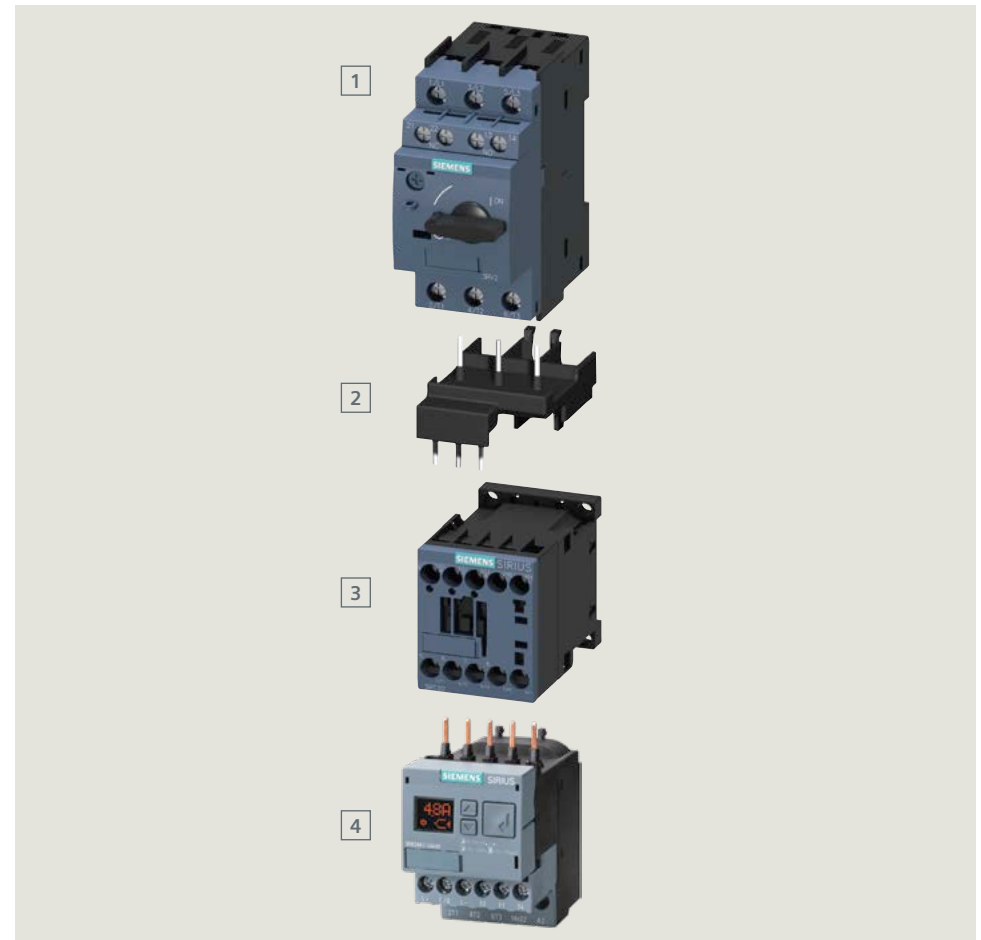

| Type | Screw terminals | Spring-loaded terminals |
|----------------------------|-----------------|-------------------------|
| 1 Motor starter protector | 3RV2011-□□□1□ | 3RV2011-□□□2□ |
| 2 Link module | 3RA1921-1DA00 | 3RA2911-2AA00 |
| 3 Contactor (AC/DC) | 3RT201□-1□□□□ | 3RT201□-2□□□□ |
| 4 Current monitoring relay | 3RR2□41-1□□□□ | 3RR2□41-2□□□□ |

Starter combinations in size S00: motor starter protector for starter protection, contactor and overload relay

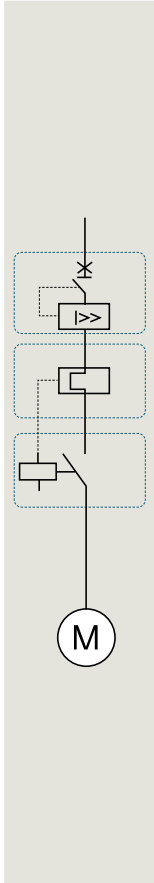

Standard three-phase motor 4-pole at 400 V AC

| [kW] | [A] |
|------|------|
| 0.04 | 0.16 |
| 0.06 | 0.20 |
| 0.06 | 0.20 |
| 0.09 | 0.30 |
| 0.09 | 0.30 |
| 0.12 | 0.44 |
| 0.18 | 0.60 |
| 0.18 | 0.60 |
| 0.25 | 0.85 |
| 0.37 | 1.10 |
| 0.55 | 1.50 |
| 0.75 | 1.90 |
| 0.75 | 1.90 |
| 1.1 | 2.70 |
| 1.5 | 3.60 |
| 1.5 | 3.60 |
| 2.2 | 4.90 |
| 3 | 6.50 |
| 4 | 8.50 |
| 5.5 | 11.5 |
| 7.5 | 15.5 |



MSPs for starter protection

| MSP rated current [A] | Article No. |
|-----------------------|---------------|
| 0.16 | 3RV2311-0AC□0 |
| 0.2 | 3RV2311-0BC□0 |
| 0.25 | 3RV2311-0CC□0 |
| 0.32 | 3RV2311-0DC□0 |
| 0.4 | 3RV2311-0EC□0 |
| 0.5 | 3RV2311-0FC□0 |
| 0.63 | 3RV2311-0GC□0 |
| 0.8 | 3RV2311-0HC□0 |
| 1 | 3RV2311-0JC□0 |
| 1.25 | 3RV2311-0KC□0 |
| 1.6 | 3RV2311-1AC□0 |
| 2 | 3RV2311-1BC□0 |
| 2.5 | 3RV2311-1CC□0 |
| 3.2 | 3RV2311-1DC□0 |
| 4 | 3RV2311-1EC□0 |
| 5 | 3RV2311-1FC□0 |
| 6.3 | 3RV2311-1GC□0 |
| 8 | 3RV2311-1HC□0 |
| 10 | 3RV2311-1JC□0 |
| 12.5 | 3RV2311-1KC□0 |
| 16 | 3RV2311-4AC□0 |

Screw terminals: 1
Spring-loaded terminals: 2



Contactors (aux. contacts 1NO or 1NC integrated)

| Rated operational current [A] | Article No. 24 V DC | Article No. 230 V AC, 50/60 Hz |
|-------------------------------|---------------------|--------------------------------|
| 7 | 3RT2015-□BB4□ | 3RT2015-□AP0□ |
| 9 | 3RT2016-□BB4□ | 3RT2016-□AP0□ |
| 12 | 3RT2017-□BB4□ | 3RT2017-□AP0□ |
| 16 | 3RT2018-□BB4□ | 3RT2018-□AP0□ |

Screw terminals: 1
Spring-loaded terminals: 2
1NO: 1
1NC: 2

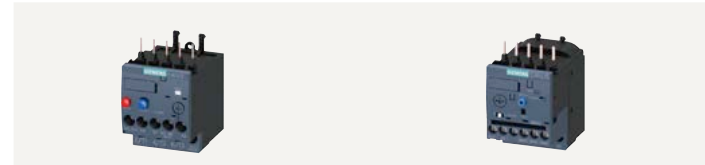

Overload relays

| Setting range [A] | Article No. thermal overload relay CLASS 10 | Setting range [A] | Article No. electronic overload relay CLASS 10E |
|-------------------|---|-------------------|---|
| 0.11 – 0.16 | 3RU2116-0A □0 | 0.1 – 0.4 | 3RB3016-1R □0 |
| 0.14 – 0.2 | 3RU2116-0B □0 | | |
| 0.18 – 0.25 | 3RU2116-0C □0 | | |
| 0.22 – 0.32 | 3RU2116-0D □0 | | |
| 0.28 – 0.4 | 3RU2116-0E □0 | 0.32 – 1.25 | 3RB3016-1N □0 |
| 0.35 – 0.5 | 3RU2116-0F □0 | | |
| 0.45 – 0.63 | 3RU2116-0G □0 | | |
| 0.55 – 0.8 | 3RU2116-0H □0 | | |
| 0.7 – 1 | 3RU2116-0J □0 | 1 – 4 | 3RB3016-1P □0 |
| 0.9 – 1.25 | 3RU2116-0K □0 | | |
| 1.1 – 1.6 | 3RU2116-1A □0 | | |
| 1.4 – 2 | 3RU2116-1B □0 | | |
| 1.8 – 2.5 | 3RU2116-1C □0 | 3 – 12 | 3RB3016-1S □0 |
| 2.2 – 3.2 | 3RU2116-1D □0 | | |
| 2.8 – 4 | 3RU2116-1E □0 | | |
| 3.5 – 5 | 3RU2116-1F □0 | | |
| 4.5 – 6.3 | 3RU2116-1G □0 | 4 – 16 | 3RB3016-1T □0 |
| 5.5 – 8 | 3RU2116-1H □0 | | |
| 7 – 10 | 3RU2116-1J □0 | | |
| 9 – 12.5 | 3RU2116-1K □0 | | |
| 11 – 16 | 3RU2116-4A □0 | | |

Screw terminals: B
Spring-loaded terminals: C
Screw terminals: E
Spring-loaded terminals: F

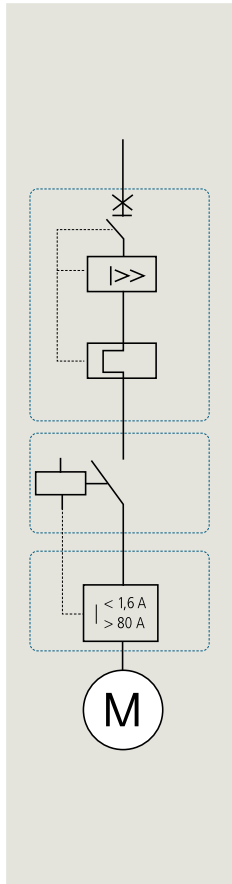

Standard three-phase motor 4-pole at 400 V AC

| [kW] | [A] |
|------|------|
| 0.04 | 0.16 |
| 0.06 | 0.20 |
| 0.06 | 0.20 |
| 0.09 | 0.30 |
| 0.09 | 0.30 |
| 0.12 | 0.44 |
| 0.18 | 0.60 |
| 0.18 | 0.60 |
| 0.25 | 0.85 |
| 0.37 | 1.10 |
| 0.55 | 1.50 |
| 0.75 | 1.90 |
| 0.75 | 1.90 |
| 1.1 | 2.70 |
| 1.5 | 3.60 |
| 1.5 | 3.60 |
| 1.5 | 4.90 |
| 3 | 6.50 |
| 4 | 8.50 |
| 5.5 | 11.5 |
| 7.5 | 15.5 |



MSPs for motor protection

Setting range for thermal overload release
CLASS 10

| [A] | Article No. |
|-------------|---------------|
| 0.11 – 0.16 | 3RV2011-0AA□0 |
| 0.14 – 0.2 | 3RV2011-0BA□0 |
| 0.18 – 0.25 | 3RV2011-0CA□0 |
| 0.22 – 0.32 | 3RV2011-0DA□0 |
| 0.28 – 0.4 | 3RV2011-0EA□0 |
| 0.35 – 0.5 | 3RV2011-0FA□0 |
| 0.45 – 0.63 | 3RV2011-0GA□0 |
| 0.55 – 0.8 | 3RV2011-0HA□0 |
| 0.7 – 1 | 3RV2011-0JA□0 |
| 0.9 – 1.25 | 3RV2011-0KA□0 |
| 1.1 – 1.6 | 3RV2011-1AA□0 |
| 1.4 – 2 | 3RV2011-1BA□0 |
| 1.8 – 2.5 | 3RV2011-1CA□0 |
| 2.2 – 3.2 | 3RV2011-1DA□0 |
| 2.8 – 4 | 3RV2011-1EA□0 |
| 3.5 – 5 | 3RV2011-1FA□0 |
| 4.5 – 6.3 | 3RV2011-1GA□0 |
| 5.5 – 8 | 3RV2011-1HA□0 |
| 7 – 10 | 3RV2011-1JA□0 |
| 9 – 12.5 | 3RV2011-1KA□0 |
| 10 – 16 | 3RV2011-4AA□0 |

Screw terminals: 1
Spring-loaded terminals: 2



Contactors (aux. contacts 1NO or 1NC integrated)

| Rated operational current [A] | Article No. | |
|-------------------------------|------------------------|--------------------|
| | Control supply voltage | |
| | DC 24 V | 230 V AC, 50/60 Hz |
| 7 | 3RT2015-□BB4□ | 3RT2015-□AP0□ |
| 9 | 3RT2016-□BB4□ | 3RT2016-□AP0□ |
| 12 | 3RT2017-□BB4□ | 3RT2017-□AP0□ |
| 16 | 3RT2018-□BB4□ | 3RT2018-□AP0□ |

Screw terminals: 1
Spring-loaded terminals: 2

1NO: 1
1NC: 2



Current monitoring relays

| Meas. range [A] | Article No. | |
|-----------------|---------------------------|--------------------------------|
| | Basic (analog adjustable) | Standard (digital adjustable)* |
| 1.6 – 16 | 3RR2141-□A□30 | 3RR2241-□F□30 |

Screw terminals: 1
Spring-loaded terminals: 2

24 V AC/DC: A
24 – 240 V AC/DC: W

Screw terminals: 1
Spring-loaded terminals: 2
24 V AC/DC: A
24 – 240 V AC/DC: W

*likewise available as 3RR24 with IO-Link

Fuseless assembly with solid-state switching devices

Assembly up to 7.5 kW (S00)

Motor starter protector for motor protection, soft starter with current monitoring relay (stand-alone installation)

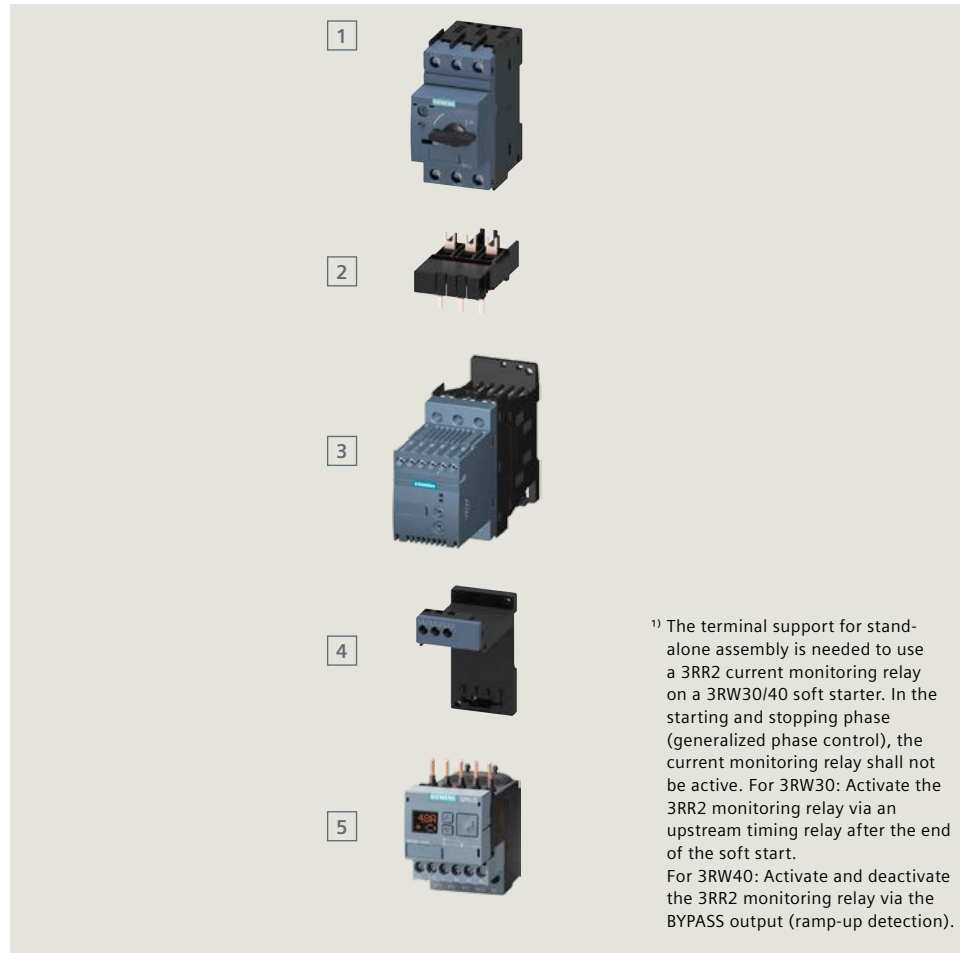

| Type | Screw terminals | Spring-loaded terminals |
|--|-----------------|-------------------------|
| 1 Motor starter protector | 3RV2011-□□□□1□ | 3RV2011-□□□□2□ |
| 2 Link module | 3RA2921-1BA00 | 3RA2911-2GA00 |
| 3 Soft starter | 3RW301□-1□□□□ | 3RW301□-2□□□□ |
| 4 Terminal support stand-alone | 3RU2916-3AA01 | 3RU2916-3AC01 |
| 5 Current monitoring relay ¹⁾ | 3RR2□41-1□□□□ | 3RR2□41-2□□□□ |

Motor starter protector for motor protection, solid-state contactor with current monitoring relay (stand-alone installation)

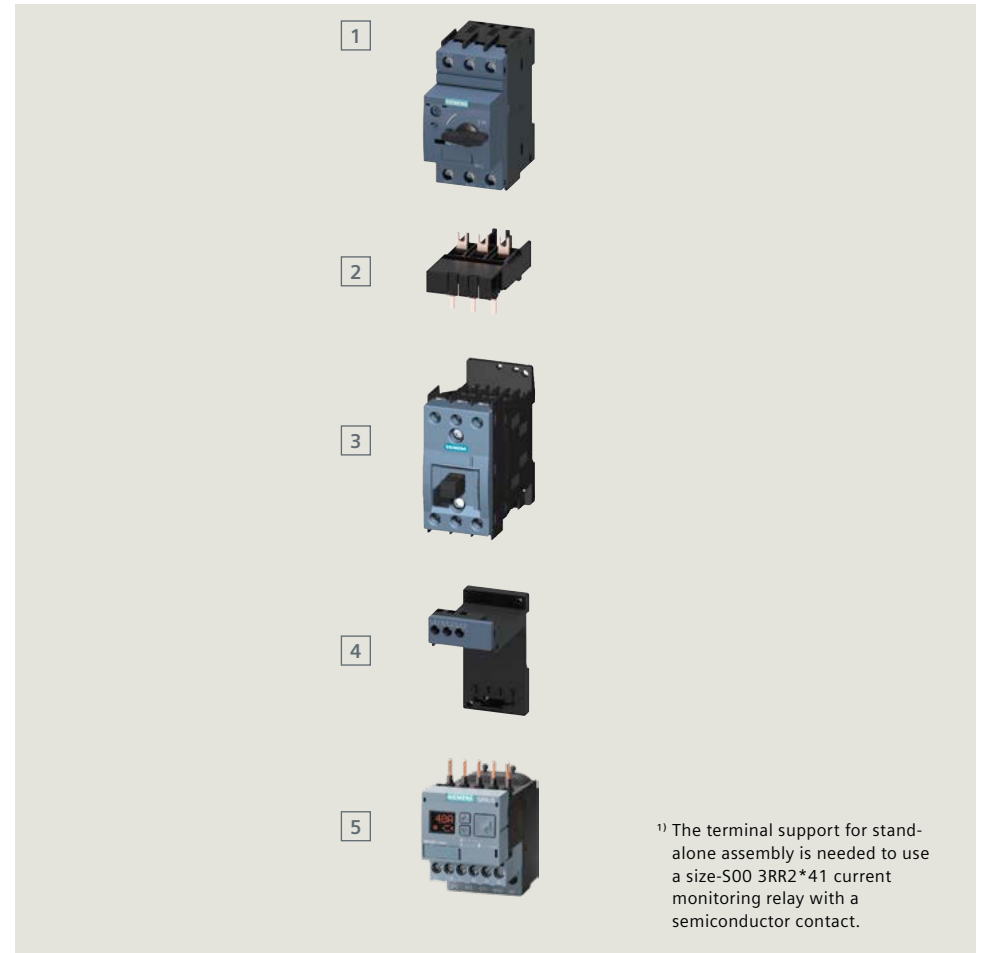

| Type | Screw terminals | Spring-loaded terminals |
|--|-----------------|-------------------------|
| 1 Motor starter protector | 3RV2011-□□□□1□ | |
| 2 Link module | 3RA2921-1BA00 | |
| 3 Solid-state cont./solid-state rev. cont. | 3RF34□□-1□□□□ | |
| 4 Terminal support stand-alone | 3RU2916-3AA01 | 3RU2916-3AC01 |
| 5 Current monitoring relay ¹⁾ | 3RR2□□-1□□□□ | 3RR2□41-2□□□□ |

Starter combinations: Motor starter protector for motor protection, soft starter with current monitoring relay

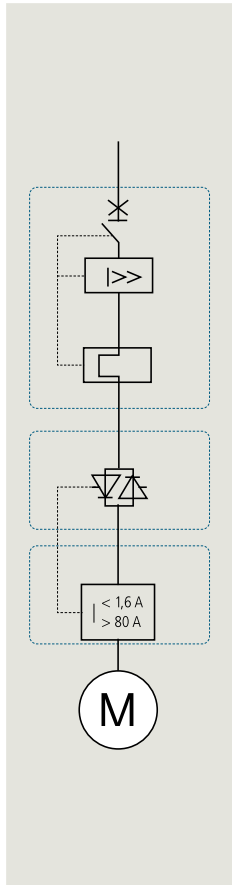

| Standard three-phase motor 4-pole at 400 V AC | |
|---|------|
| [kW] | [A] |
| 0.04 | 0.16 |
| 0.06 | 0.20 |
| 0.06 | 0.20 |
| 0.09 | 0.30 |
| 0.09 | 0.30 |
| 0.12 | 0.44 |
| 0.18 | 0.60 |
| 0.18 | 0.60 |
| 0.25 | 0.85 |
| 0.37 | 1.10 |
| 0.55 | 1.50 |
| 0.75 | 1.90 |
| 0.75 | 1.90 |
| 1.1 | 2.70 |
| 1.5 | 3.60 |
| 1.5 | 3.60 |
| 2.2 | 4.90 |
| 3 | 6.50 |
| 4 | 8.50 |
| 5.5 | 11.5 |
| 7.5 | 15.5 |





| Motor starter protectors | |
|---|---------------|
| Setting range for thermal overload release CLASS 10 | |
| [A] | Article No. |
| 0.11 – 0.16 | 3RV2011-0AA□0 |
| 0.14 – 0.2 | 3RV2011-0BA□0 |
| 0.18 – 0.25 | 3RV2011-0CA□0 |
| 0.22 – 0.32 | 3RV2011-0DA□0 |
| 0.28 – 0.4 | 3RV2011-0EA□0 |
| 0.35 – 0.5 | 3RV2011-0FA□0 |
| 0.45 – 0.63 | 3RV2011-0GA□0 |
| 0.55 – 0.8 | 3RV2011-0HA□0 |
| 0.7 – 1 | 3RV2011-0JA□0 |
| 0.9 – 1.25 | 3RV2011-0KA□0 |
| 1.1 – 1.6 | 3RV2011-1AA□0 |
| 1.4 – 2 | 3RV2011-1BA□0 |
| 1.8 – 2.5 | 3RV2011-1CA□0 |
| 2.2 – 3.2 | 3RV2011-1DA□0 |
| 2.8 – 4 | 3RV2011-1EA□0 |
| 3.5 – 5 | 3RV2011-1FA□0 |
| 4.5 – 6.3 | 3RV2011-1GA□0 |
| 5.5 – 8 | 3RV2011-1HA□0 |
| 7 – 10 | 3RV2011-1JA□0 |
| 9 – 12.5 | 3RV2011-1KA□0 |
| 10 – 16 | 3RV2011-4AA□0 |

Screw terminals: ①
Spring-loaded terminals: ②



| Soft starters ¹⁾ | | |
|-------------------------------|---------------|--------------------|
| Rated operational current [A] | Article No. | |
| | 24 V DC | 230 V AC, 50/60 Hz |
| 3.6 | 3RW3013-□BB04 | 3RW3013-□BB14 |
| 6.5 | 3RW3014-□BB04 | 3RW3014-□BB14 |
| 9 | 3RW3016-□BB04 | 3RW3016-□BB14 |
| 12.5 | 3RW3017-□BB04 | 3RW3017-□BB14 |
| 17.6 | 3RW3018-□BB04 | 3RW3018-□BB14 |

Screw terminals: ①
Spring-loaded terminals: ②

| Current monitoring relays | | |
|---------------------------|---------------------------|--------------------------------|
| Meas. range [A] | Article No. | |
| | Basic (analog adjustable) | Standard (digital adjustable)* |
| 1.6 – 16 | 3RR2141-□A□30 | 3RR2241-□F□30 |

Screw terminals: ①
Spring-loaded terminals: ②
24 V AC/DC: ③
24 – 240 V AC/DC: ④

Screw terminals: ①
Spring-loaded terminals: ②
24 V AC/DC: ③
24 – 240 V AC/DC: ④

¹⁾ Rated operational voltage 200 – 480 V

*likewise available as 3RR24 with IO-Link

Starter combinations: motor starter protector for motor protection, solid-state switching device and current monitoring relay

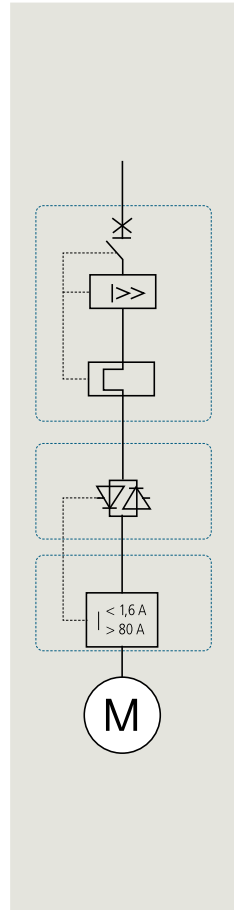

| Standard three-phase motor 4-pole at 400 V AC | |
|---|------|
| [kW] | [A] |
| 0.04 | 0.16 |
| 0.06 | 0.20 |
| 0.06 | 0.20 |
| 0.09 | 0.30 |
| 0.09 | 0.30 |
| 0.12 | 0.44 |
| 0.18 | 0.60 |
| 0.18 | 0.60 |
| 0.25 | 0.85 |
| 0.37 | 1.10 |
| 0.55 | 1.50 |
| 0.75 | 1.90 |
| 0.75 | 1.90 |
| 1.1 | 2.70 |
| 1.5 | 3.60 |
| 1.5 | 3.60 |
| 2.2 | 4.90 |
| 3 | 6.50 |
| 4 | 8.50 |
| 5.5 | 11.5 |
| 7.5 | 15.5 |



| Motor starter protectors | |
|---|---------------|
| Setting range for thermal overload release CLASS 10 | |
| [A] | Article No. |
| 0.11 – 0.16 | 3RV2011-0AA□0 |
| 0.14 – 0.2 | 3RV2011-0BA□0 |
| 0.18 – 0.25 | 3RV2011-0CA□0 |
| 0.22 – 0.32 | 3RV2011-0DA□0 |
| 0.28 – 0.4 | 3RV2011-0EA□0 |
| 0.35 – 0.5 | 3RV2011-0FA□0 |
| 0.45 – 0.63 | 3RV2011-0GA□0 |
| 0.55 – 0.8 | 3RV2011-0HA□0 |
| 0.7 – 1 | 3RV2011-0JA□0 |
| 0.9 – 1.25 | 3RV2011-0KA□0 |
| 1.1 – 1.6 | 3RV2011-1AA□0 |
| 1.4 – 2 | 3RV2011-1BA□0 |
| 1.8 – 2.5 | 3RV2011-1CA□0 |
| 2.2 – 3.2 | 3RV2011-1DA□0 |
| 2.8 – 4 | 3RV2011-1EA□0 |
| 3.5 – 5 | 3RV2011-1FA□0 |
| 4.5 – 6.3 | 3RV2011-1GA□0 |
| 5.5 – 8 | 3RV2011-1HA□0 |
| 7 – 10 | 3RV2011-1JA□0 |
| 9 – 12.5 | 3RV2011-1KA□0 |
| 10 – 16 | 3RV2011-4AA□0 |

Screw terminals: 1
Spring-loaded terminals: 2



| Solid-state contactors ²⁾ | | |
|--------------------------------------|-----------------------------|-----------------------------|
| Rated operational current [A] | Article No. | Article No. |
| | Control supply voltage | |
| | 24 V DC | 110 – 230 V AC, 50/60 Hz |
| 5.2 | 3RF3405-□BB04 | 3RF3405-□BB24 |
| 9.2 | 3RF3410-□BB04 ¹⁾ | 3RF3410-□BB24 ¹⁾ |
| 12.5 | 3RF3412-□BB04 ¹⁾ | 3RF3412-□BB24 ¹⁾ |
| 16 | 3RF3416-□BB04 ¹⁾ | 3RF3416-□BB24 ¹⁾ |

Screw terminals: 1
Spring-loaded terminals: 2

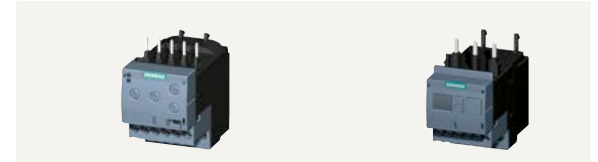

| Current monitoring relays | | |
|---------------------------|---------------------------------------|--|
| Meas. range [A] | Article No. Basic (analog adjustable) | Article No. Standard (digital adjustable)* |
| | 1.6 – 16 | 3RR2141-□A□30 ³⁾ |

Screw terminals: 1
Spring-loaded terminals: 2
24 V AC/DC: A
24 – 240 V AC/DC: M

*likewise available as 3RR24 with IO-Link

| Solid-state reversing contactors ²⁾ | | |
|--|-----------------------------|-----------------------------|
| 3.8 | 3RF3403-1BD04 | 3RF3403-1BD24 |
| 5.4 | 3RF3405-1BD04 | 3RF3405-1BD24 |
| 7.4 | 3RF3410-1BD04 ¹⁾ | 3RF3410-1BD24 ¹⁾ |

¹⁾ Width 90 mm

²⁾ Rated operational voltage U_e 48 – 480 V

³⁾ Can be mounted directly on solid-state contactor with screw terminals using connection adapter 3RF3900-0QA88

Fuseless assembly Assembly 18.5 kW (S0)

Motor starter protector for starter protection, contactor and overload relay

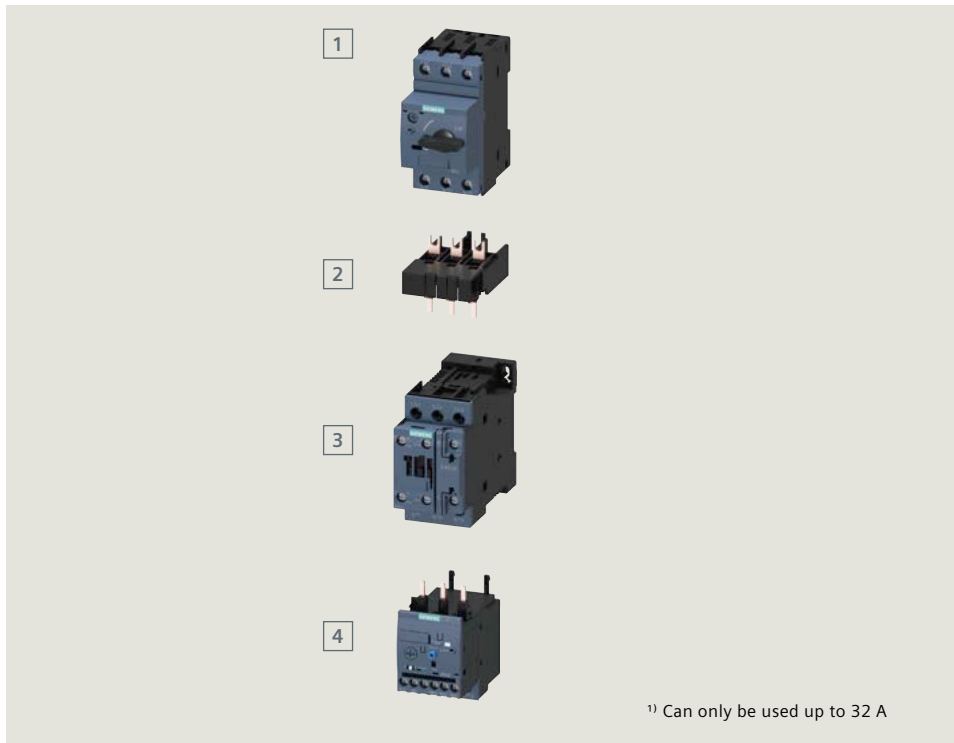

| | Type | Screw terminals | Spring-loaded terminals |
|---|---------------------------|--------------------------------------|-----------------------------------|
| 1 | Motor starter protector | 3RV2321-□□□1□ | 3RV2321-□□□2□ |
| 2 | Link module ¹⁾ | AC 3RA2921-1AA00 DC 3RA2921-1BA00 | 3RA2921-2AA00 3RA2921-2AA00 |
| 3 | Contactor | 3RT202□-1□□□□ | 3RT202□-2□□□□ |
| 4 | Overload relay | 3RU2126-□□□B0 or 3RB3□2□-□□□B0 | 3RU2126-□□□C0 or 3RB3□2□-□□□E0 |

Motor starter protector for motor protection, contactor with current monitoring relay

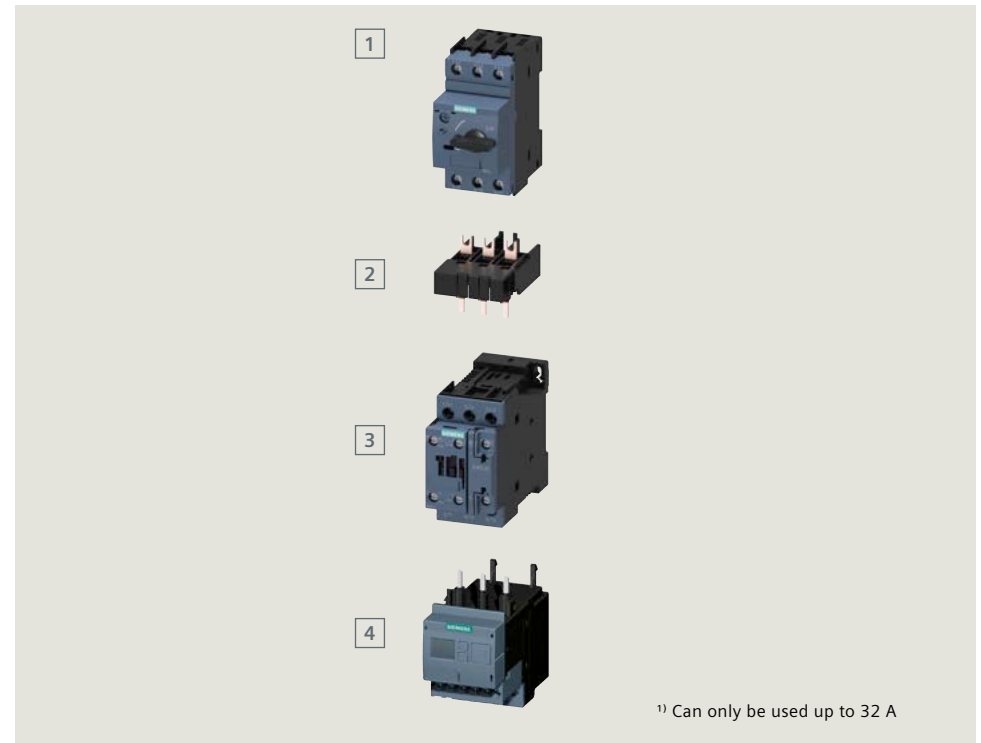

| | Type | Screw terminals | Spring-loaded terminals |
|---|---------------------------|--------------------------------------|--------------------------------|
| 1 | Motor starter protector | 3RV2021-□□□1□ | 3RV2021-□□□2□ |
| 2 | Link module ¹⁾ | AC 3RA2921-1AA00 DC 3RA2921-1BA00 | 3RA2921-2AA00 3RA2921-2AA00 |
| 3 | Contactor | 3RT202□-1□□□□ | 3RT202□-2□□□□ |
| 4 | Current monitoring relay | 3RR2□42-1□□□□ | 3RR2□42-2□□□□ |

Starter combinations size S0: Motor starter protector for starter protection, contactor and overload relay

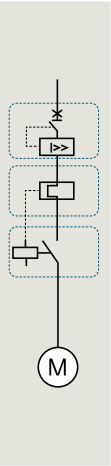

| Standard three-phase motor 4-pole at 400 V AC | |
|---|------|
| [kW] | [A] |
| 7.5 | 15.5 |
| 7.5 | 15.5 |
| 11 | 22 |
| 11 | 22 |
| 15 | 29 |
| 15 | 29 |
| 18.5 | 35 |
| 18.5 | 35 |

| MSPs for starter protection | |
|-----------------------------|---------------|
| MSP rated current [A] | Article No. |
| 16 | 3RV2321-4AC□0 |
| 20 | 3RV2321-4BC□0 |
| 22 | 3RV2321-4CC□0 |
| 25 | 3RV2321-4DC□0 |
| 28 | 3RV2321-4NC□0 |
| 32 | 3RV2321-4EC□0 |
| 36 | 3RV2321-4PC10 |
| 40 | 3RV2321-4FC10 |

| Contactors (auxiliary contacts 1NO or 1NC integrated) | | | |
|---|------------------------|-----------------|----------------|
| Rated operational current [A] | Article No. | | |
| | Control supply voltage | | |
| | 24 V DC | 230 V AC, 50 Hz | 50/60 Hz AC/DC |
| 17 | 3RT2025-□BB40 | 3RT2025-□AP00 | 3RT2025-□N□30 |
| 25 | 3RT2026-□BB40 | 3RT2026-□AP00 | 3RT2026-□N□30 |
| 32 | 3RT2027-□BB40 | 3RT2027-□AP00 | 3RT2027-□N□30 |
| 38 | 3RT2028-□BB40 | 3RT2028-□AP00 | 3RT2028-□N□30 |

| Overload relays | |
|-------------------|---|
| Setting range [A] | Article No. thermal overload relay CLASS 10 |
| 11 – 16 | 3RU2126-4A□0 |
| 14 – 20 | 3RU2126-4B□0 |
| 17 – 22 | 3RU2126-4C□0 |
| 20 – 25 | 3RU2126-4D□0 |
| 23 – 28 | 3RU2126-4N□0 |
| 27 – 32 | 3RU2126-4E□0 |
| 30 – 36 | 3RU2126-4P□0 |
| 34 – 40 | 3RU2126-4F□0 |

| Setting range [A] | Article No. electronic overload relay CLASS 10E |
|-------------------|---|
| 6 – 25 | 3RB3026-1Q□0 |
| 10 – 40 | 3RB3026-1V□0 |

Screw terminals: ①
Spring-loaded terminals²⁾: ②

Screw terminals: ① 21 – 28 V AC/DC: ②
Spring-loaded terminals: ② 95 – 130 V AC/DC: ③
200 – 280 V AC/DC: ④

Screw terminals: ②
Spring-loaded terminals: ③

Screw terminals: ②
Spring-loaded terminals: ③

Starter combinations size S0: Motor starter protector for motor protection, contactor and current monitoring relay

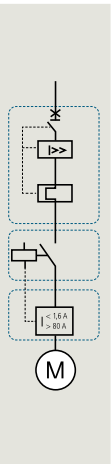

| Standard three-phase motor 4-pole at 400 V AC | |
|---|------|
| [kW] | [A] |
| 7.5 | 15.5 |
| 7.5 | 15.5 |
| 11 | 22 |
| 11 | 22 |
| 15 | 29 |
| 15 | 29 |
| 18.5 | 35 |
| 18.5 | 35 |

| MSPs for motor protection | |
|---|---------------|
| Setting range for thermal overload release CLASS 10 [A] | Article No. |
| 10 – 16 | 3RV2021-4AA□0 |
| 13 – 20 | 3RV2021-4BA□0 |
| 16 – 22 | 3RV2021-4CA□0 |
| 18 – 25 | 3RV2021-4DA□0 |
| 23 – 28 | 3RV2021-4NA□0 |
| 27 – 32 | 3RV2021-4EA□0 |
| 30 – 36 | 3RV2021-4PA10 |
| 34 – 40 | 3RV2021-4FA10 |

| Contactors (auxiliary contacts 1NO or 1NC integrated) | | | |
|---|------------------------|-----------------|----------------|
| Rated operational current [A] | Article No. | | |
| | Control supply voltage | | |
| | 24 V DC | 230 V AC, 50 Hz | 50/60 Hz AC/DC |
| 17 | 3RT2025-□BB40 | 3RT2025-□AP00 | 3RT2025-□N□30 |
| 25 | 3RT2026-□BB40 | 3RT2026-□AP00 | 3RT2026-□N□30 |
| 32 | 3RT2027-□BB40 | 3RT2027-□AP00 | 3RT2027-□N□30 |
| 38 | 3RT2028-□BB40 | 3RT2028-□AP00 | 3RT2028-□N□30 |

| Current monitoring relays | | |
|---------------------------|---------------------------------------|--|
| Meas. range [A] | Article No. Basic (analog adjustable) | Article No. Standard (digital adjustable)* |
| 4 – 40 | 3RR2142-□A□30 | 3RR2242-□F□30 |

Screw terminals: ①
Spring-loaded terminals²⁾: ②

Screw terminals: ① 21 – 28 V AC/DC: ②
Spring-loaded terminals: ② 95 – 130 V AC/DC: ③
200 – 280 V AC/DC: ④

Screw terminals: ①
Spring-loaded terminals: ②
24 V AC/DC: ③
24 – 240 V AC/DC: ④

²⁾ Up to 32 A

*likewise available as 3RR24 with IO-Link

Fuseless assembly

Assembly up to 18.5 kW (S0)

Motor starter protector for motor protection, 3RW30 soft starter with current monitoring relay (stand-alone installation)

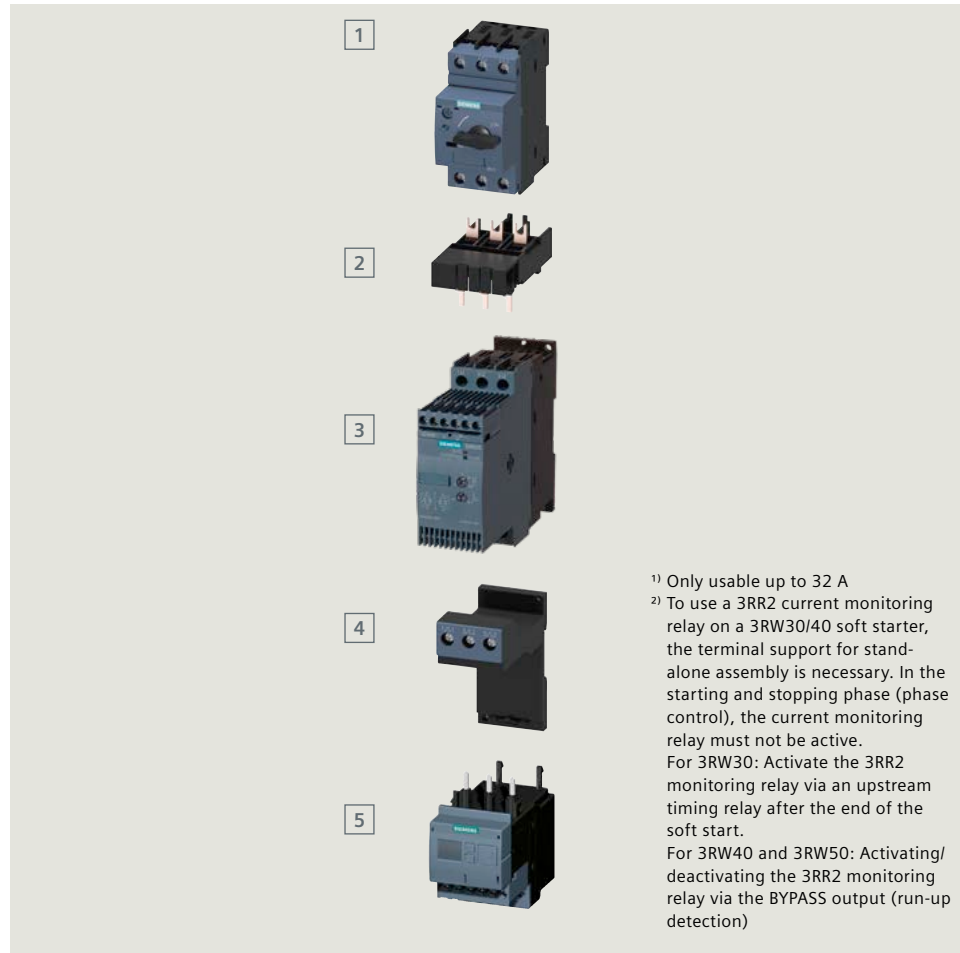

| Type | Screw terminals | Spring-loaded terminals |
|--|-----------------|-------------------------|
| 1 Motor starter protector | 3RV2021-□□□□1□ | 3RV2021-□□□□2□ |
| 2 Link module ¹⁾ | 3RA2921-1BA00 | 3RA2921-2GA00 |
| 3 Soft starter | 3RW302□-1□□□□ | 3RW302□-2□□□□ |
| 4 Terminal support stand-alone | 3RU2926-3AA01 | 3RU2926-3AC01 |
| 5 Current monitoring relay ²⁾ | 3RR2□42-1□□□□ | 3RR2□42-2□□□□ |

Motor starter protectors for motor protection, 3RW40 soft starter (integrated electronic overload relay)



| Type | Screw terminals | Spring-loaded terminals |
|-----------------------------|-----------------|-------------------------|
| 1 Motor starter protector | 3RV2021-□□□□1□ | 3RV2021-□□□□2□ |
| 2 Link module ¹⁾ | 3RA2921-1BA00 | 3RA2921-2GA00 |
| 3 Soft starter | 3RW402□-1□□□□ | 3RW402□-2□□□□ |

Starter combinations in size S0: Motor starter protector for motor protection, 3RW30 soft starter and current monitoring relay

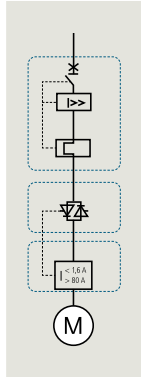

Standard three-phase motor 4-pole at 400 V

| [kW] | [A] |
|------|-----|
| 11 | 22 |
| 11 | 22 |
| 15 | 29 |
| 15 | 29 |
| 18.5 | 35 |
| 18.5 | 35 |

¹⁾ Rated operational voltage 200 – 480 V



MSPs for motor protection

Setting range for thermal overload release CLASS 10

| [A] | Article No. |
|---------|----------------|
| 16 – 22 | 3RV2021-4CA □0 |
| 18 – 25 | 3RV2021-4DA □0 |
| 23 – 28 | 3RV2021-4NA □0 |
| 27 – 32 | 3RV2021-4EA □0 |
| 30 – 36 | 3RV2021-4PA10 |
| 34 – 40 | 3RV2021-4FA10 |

Screw terminals: 1
Spring-loaded terminals up to 32 A: 2



Soft starters¹⁾ without overload protection

| Rated operational current [A] | Article No. | |
|-------------------------------|------------------------|-------------------|
| | Control supply voltage | |
| 25 | 24 V AC/DC | 110 – 230 V AC/DC |
| | 3RW3026-□BB04 | 3RW3026-□BB14 |
| 32 | 24 V AC/DC | 110 – 230 V AC/DC |
| | 3RW3027-□BB04 | 3RW3027-□BB14 |
| 38 | 24 V AC/DC | 110 – 230 V AC/DC |
| | 3RW3028-□BB04 | 3RW3028-□BB14 |

Screw terminals: 1
Spring-loaded terminals: 2

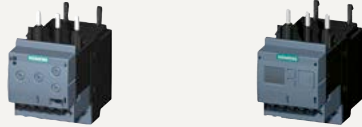

Current monitoring relays

| Meas. range [A] | Article No. | |
|-----------------|---------------------------|--------------------------------|
| | Basic (analog adjustable) | Standard (digital adjustable)* |
| 4 – 40 | 24 V AC/DC | 110 – 230 V AC/DC |
| | 3RR2142-□A□30 | 3RR2242-□F□30 |

Screw terminals: 1 24 V AC/DC: A
Spring-loaded terminals: 2 24 – 240 V AC/DC: W

*likewise available as 3RR24 with IO-Link

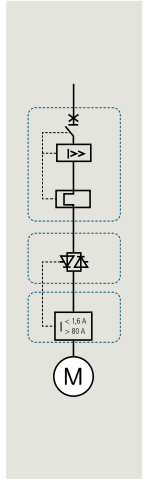

Standard three-phase motor 4-pole at 400 V AC

| [kW] | [A] |
|------|------|
| 5.5 | 11.5 |
| 7.5 | 15.5 |
| 7.5 | 15.5 |
| 11 | 22 |
| 11 | 22 |
| 15 | 29 |
| 15 | 29 |
| 18.5 | 35 |
| 18.5 | 35 |



MSPs for motor protection

Setting range for thermal overload release CLASS 10

| [A] | Article No. |
|----------|----------------|
| 9 – 12.5 | 3RV2021-1KA □0 |
| 10 – 16 | 3RV2021-4AA □0 |
| 13 – 20 | 3RV2021-4BA □0 |
| 16 – 22 | 3RV2021-4CA □0 |
| 18 – 25 | 3RV2021-4DA □0 |
| 23 – 28 | 3RV2021-4NA □0 |
| 27 – 32 | 3RV2021-4EA □0 |
| 30 – 36 | 3RV2021-4PA10 |
| 34 – 40 | 3RV2021-4FA10 |

Screw terminals: 1
Spring-loaded terminals up to 32 A 2



Soft starters¹⁾ with overload protection

| Rated operational current [A] | Article No. | |
|-------------------------------|------------------------|-------------------|
| | Control supply voltage | |
| | 24 V AC/DC | 110 – 230 V AC/DC |
| 12.5 | 3RW4024-□BB04 | 3RW4024-□BB14 |
| 25 | 3RW4026-□BB04 | 3RW4026-□BB14 |
| 32 | 3RW4027-□BB04 | 3RW4027-□BB14 |
| 38 | 3RW4028-□BB04 | 3RW4028-□BB14 |

Screw terminals: 1
Spring-loaded terminals: 2



Current monitoring relays

| Meas. range [A] | Article No. | |
|-----------------|---------------------------|-------------------------------|
| | Basic (analog adjustable) | Standard (digital adjustable) |
| 4 – 40 | 3RR2142-□A□30 | 3RR2242-□F□30 |

Screw terminals: 1 24 V AC/DC: A
Spring-loaded terminals: 2 24 – 240 V AC/DC: W

¹⁾ Rated operational voltage 200 – 480 V

Fuseless assembly

Size S2 up to 37 kW

Motor starter protector for starter protection, contactor and overload relay

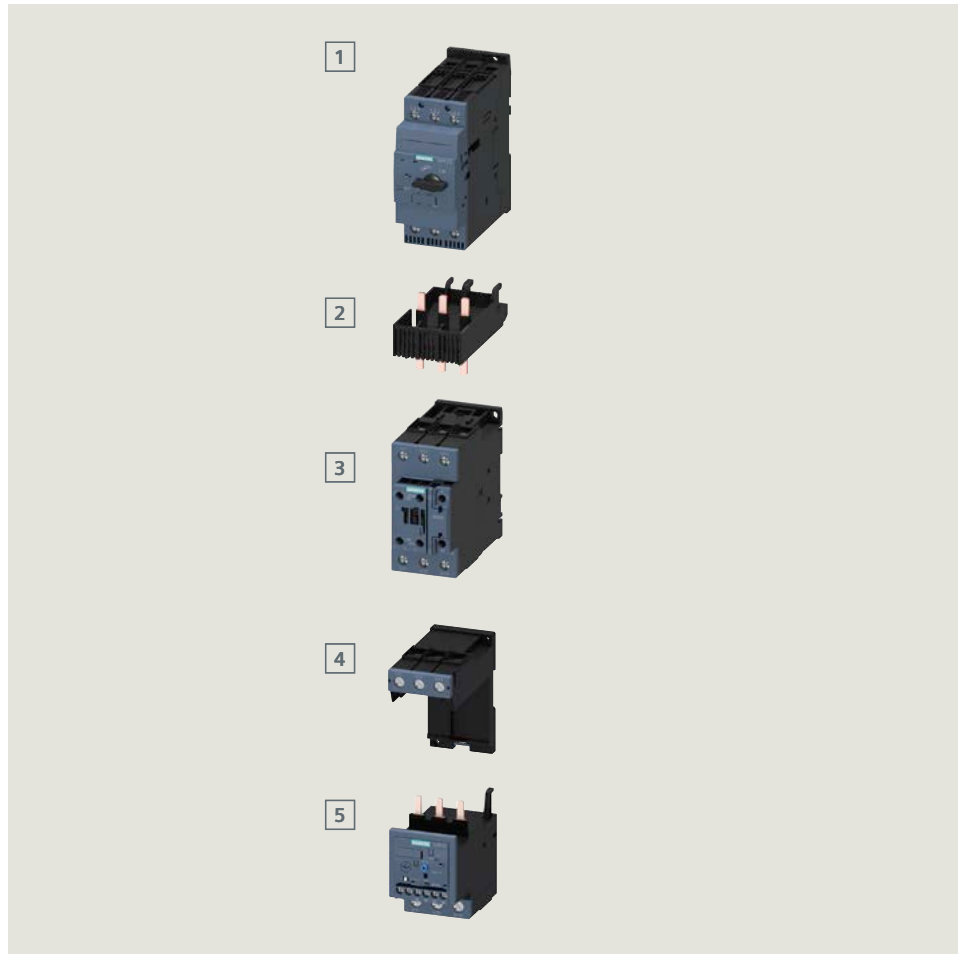

| Type | Article number |
|---|------------------------------|
| 1 Motor starter protector | 3RV233□-□□□1□ |
| 2 Link module (can only be used up to 65 A) | 3RA2931-1AA00 |
| 3 Contactor | 3RT203□-□□□□□ |
| 4 Terminal support for stand-alone installation | 3RU2936-3AA01 |
| 5 Overload relay | 3RU2136-□□B0 or 3RB3□3□-□□B0 |

Motor starter protector for motor protection, contactor with current monitoring relay

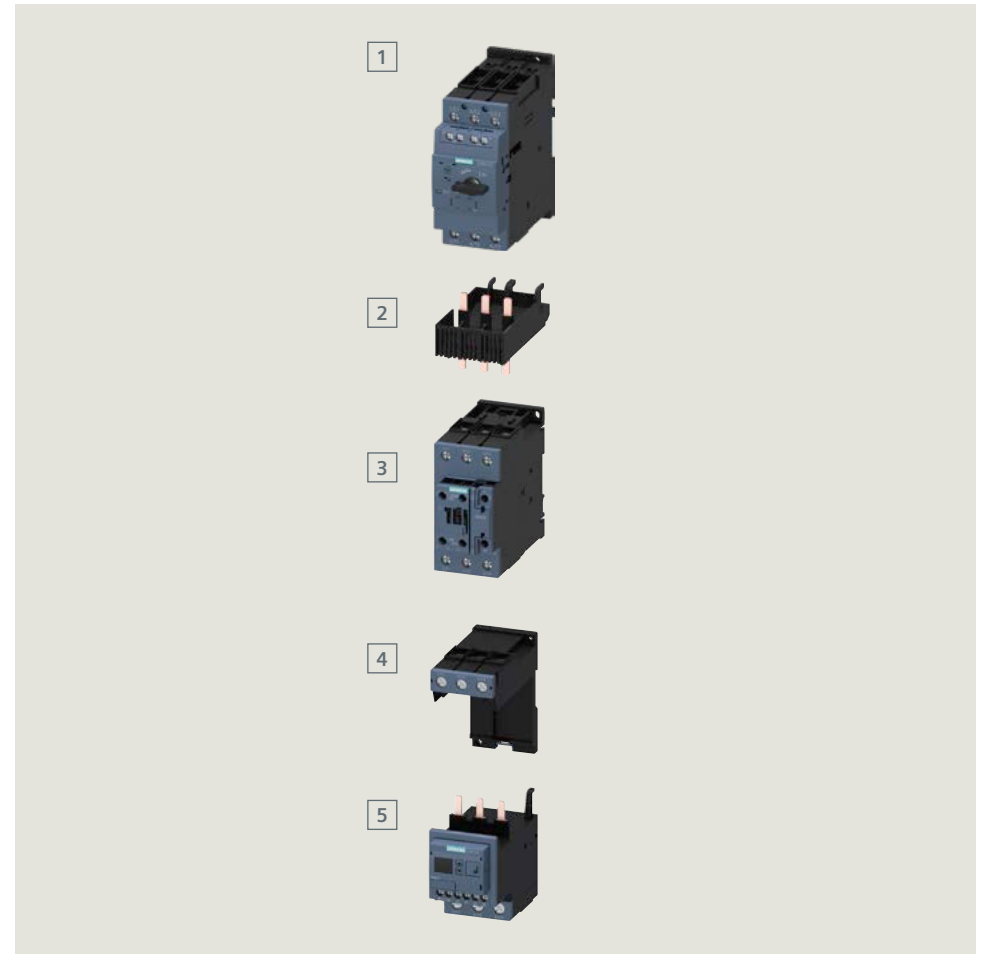

| Type | Article number |
|---|----------------|
| 1 Motor starter protector | 3RV203□-□□□1□ |
| 2 Link module (can only be used up to 65 A) | 3RA2931-1AA00 |
| 3 Contactor | 3RT203□-□□□□□ |
| 4 Terminal support for stand-alone installation | 3RU2936-3AA01 |
| 5 Current monitoring relay | 3RR2□43-1□□□□ |

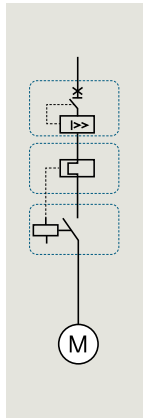

| Standard three-phase motor 4-pole at 400 V AC | |
|---|-----|
| [kW] | [A] |
| 18.5 | 35 |
| 22 | 41 |
| 30 | 55 |
| 37 | 66 |



| MSPs for starter protection | |
|-----------------------------|--------------|
| Rated breaker current [A] | Article No. |
| 36 | 3RV233-4PC10 |
| 40 | 3RV233-4UC10 |
| 45 | 3RV233-4VC10 |
| 52 | 3RV233-4WC10 |
| 59 | 3RV233-4XC10 |
| 65 | 3RV233-4JC10 |
| 73 | 3RV233-4KC10 |
| 80 ²⁾ | 3RV233-4RC10 |

Standard switching capacity 65 kA at 400 V:
 Increased switching capacity 100 kA at 400 V:



| Contactors (auxiliary contacts 1NO or 1NC integrated) | | |
|---|-----------------|----------------|
| Rated operational current [A] | Article No. | Article No. |
| | 230 V AC, 50 Hz | 50/60 Hz AC/DC |
| 40 | 3RT2035-AP00 | 3RT2035-N30 |
| 50 | 3RT2036-AP00 | 3RT2036-N30 |
| 65 | 3RT2037-AP00 | 3RT2037-N30 |
| 80 | 3RT2038-AP00 | 3RT2038-N30 |

Screw terminals: 20 – 33 V AC/DC:
 Spring-loaded terminals in auxiliary circuit: 83 – 155 V AC/DC:
 175 – 280 V AC/DC:



| Overload relays | |
|-------------------|--|
| Setting range [A] | Article No. thermal overload relay, CLASS 10 |
| 22 – 32 | 3RU2136-4EB0 |
| 28 – 40 | 3RU2136-4FB0 |
| 36 – 45 | 3RU2136-4GB0 |
| 40 – 50 | 3RU2136-4HB0 |
| 47 – 57 | 3RU2136-4QB0 |
| 54 – 65 | 3RU2136-4JB0 |
| 62 – 73 | 3RU2136-4KB0 |
| 70 – 80 | 3RU2136-4RB0 |



| Setting range [A] | Article No. electronic overload relay CLASS 10E ¹⁾ |
|-------------------|---|
| 20 – 80 | 3RB3036-1W |

Contactor mounting:
 Straight-thr. transf.:

¹⁾ As 3RB3133 also available with another CLASS and other functions

Starter combinations in size S2: Motor starter protector for motor protection, contactor with current monitoring relay

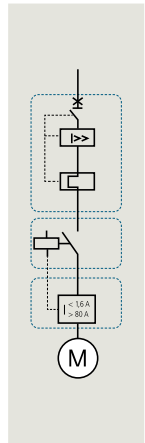

| Standard three-phase motor 4-pole at 400 V AC | |
|---|-----|
| [kW] | [A] |
| 18.5 | 35 |
| 22 | 41 |
| 30 | 55 |
| 37 | 66 |





| MSPs for motor protection | |
|---|--------------|
| Setting range for thermal overload release CLASS 10 | |
| [A] | Article No. |
| 28 – 36 | 3RV203-4PA10 |
| 32 – 40 | 3RV203-4UA10 |
| 35 – 45 | 3RV203-4VA10 |
| 42 – 52 | 3RV203-4WA10 |
| 49 – 59 | 3RV203-4XA10 |
| 54 – 65 | 3RV203-4JA10 |
| 62 – 73 | 3RV203-4KA10 |
| 70 – 80 ²⁾ | 3RV203-4RA10 |

Standard switching capacity 65 kA at 400 V: 1
 Increased switching capacity 100 kA at 400 V: 2



| Contactors (auxiliary contacts 1NO or 1NC integrated) | | |
|---|-----------------|----------------|
| Rated operational current | Article No. | Article No. |
| [A] | 230 V AC, 50 Hz | 50/60 Hz AC/DC |
| 40 | 3RT2035-AP00 | 3RT2035-N30 |
| 50 | 3RT2036-AP00 | 3RT2036-N30 |
| 65 | 3RT2037-AP00 | 3RT2037-N30 |
| 80 | 3RT2038-AP00 | 3RT2038-N30 |

Screw terminals: 1 20 – 33 V AC/DC: B
 Spring-loaded terminals in auxiliary circuit: 3 83 – 155 V AC/DC: F
 175 – 280 V AC/DC: P

| Current monitoring relays | | |
|---------------------------|---------------------------------------|--|
| Meas. range | Article No. Basic (analog adjustable) | Article No. Standard (digital adjustable)* |
| [A] | | |
| 8 – 80 | 3RR2143-A30 | 3RR2243-F30 |

Screw terminals: 1 24 V AC/DC: A
 Spring-loaded terminals in auxiliary circuit: 3 24 – 240 V AC/DC: W

*likewise available as 3RR24 with IO-Link

²⁾ Suitable for use with IE3 motors up to a starting current of 720 A. For higher starting currents we recommend using 3RV1 motor starter protectors size S3.

Fuseless assembly

Size S2 up to 37 kW

Motor starter protector for motor protection, 3RW30 soft starter without overload protection and current monitoring relay (stand-alone installation)

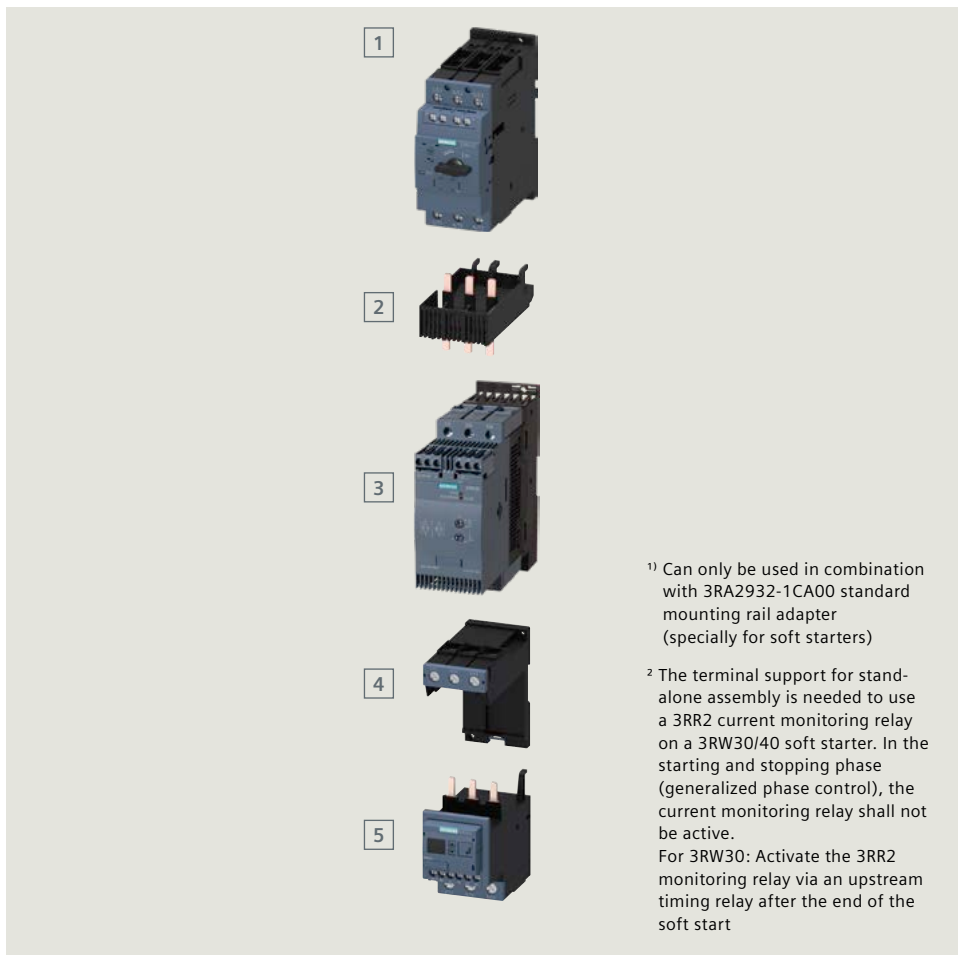

| Type | Screw terminals |
|---|-----------------|
| 1 Motor starter protector | 3RV203□-□□□1□ |
| 2 Link module (can only be used up to 65 A) ¹⁾ | 3RA2931-1AA00 |
| 3 Soft starter | 3RW303□-1□□□□ |
| 4 Terminal support for stand-alone installation | 3RU2936-3AA01 |
| 5 Current monitoring relay ²⁾ | 3RR2□43-3□□□□ |

Motor starter protector for motor protection, 3RW40 soft starter with overload protection and current monitoring relay (stand-alone installation)

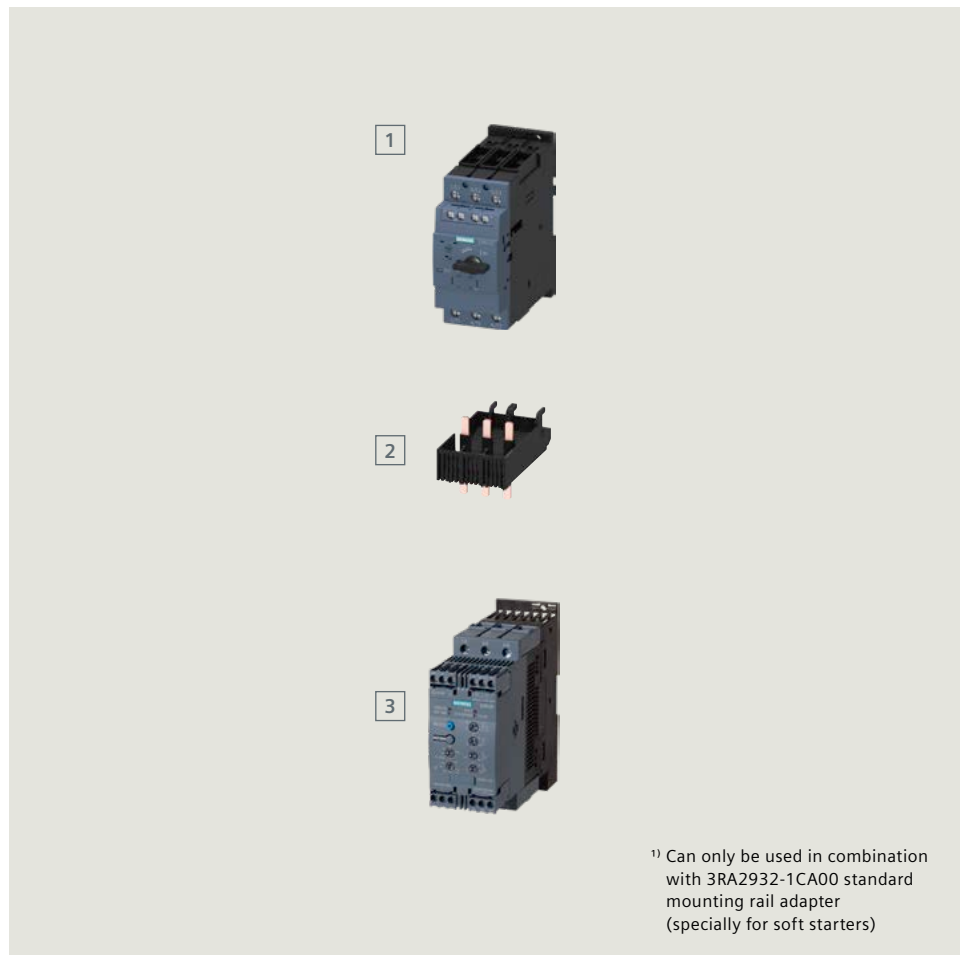

| Type | Screw terminals |
|---|-----------------|
| 1 Motor starter protector | 3RV203□-□□□1□ |
| 2 Link module (can only be used up to 65 A) ¹⁾ | 3RA2931-1AA00 |
| 3 Soft starter | 3RW403□-1□□□□ |

Starter combinations in size S2: Motor starter protector for motor protection, 3RW30 soft starter without overload protection but with current monitoring relay

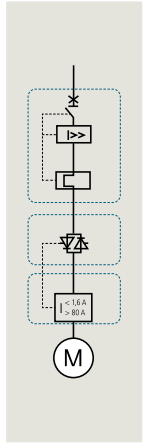

Standard three-phase motor 4-pole at 400 V AC

| [kW] | [A] |
|------|-----|
| 18.5 | 35 |
| 22 | 41 |
| 30 | 55 |
| 37 | 66 |





MSPs for motor protection
Setting range for thermal overload release CLASS 10

| [A] | Article No. |
|---------|--------------|
| 28 – 36 | 3RV203-4PA10 |
| 32 – 40 | 3RV203-4UA10 |
| 35 – 45 | 3RV203-4VA10 |
| 42 – 52 | 3RV203-4WA10 |
| 49 – 59 | 3RV203-4XA10 |
| 54 – 65 | 3RV203-4JA10 |
| 62 – 73 | 3RV203-4KA10 |
| 70 – 80 | 3RV203-4RA10 |



Soft starter without overload prot.

| Rated operational current [A] | Article No. |
|-------------------------------|---------------|
| 45 | 3RW3036-1BB-4 |
| 63 | 3RW3037-1BB-4 |
| 72 | 3RW3038-1BB-4 |

Current monitoring relays

| Meas. range [A] | Article No. Basic (analog adjustable) | Article No. Standard (digital adjustable) |
|-----------------|---------------------------------------|---|
| 8 – 80 | 3RR2143-□A□30 | 3RR2243-□F□30 |

Standard switching capacity 65 kA at 400 V: ①
Increased switching capacity 100 kA at 400 V: ②

24 V AC/DC: ④
110 – 230 V AC/DC: ①

Screw terminals: ① 24 V AC/DC: ④
Spring-loaded terminals in auxiliary circuit: ③ 110 – 230 V AC/DC: ④

Starter combinations in size S2: Motor starter protector for motor protection, 3RW40 soft starter with overload protection and current monitoring relay

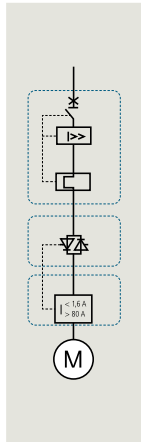

Standard three-phase motor 4-pole at 400 V

| [kW] | [A] |
|------|-----|
| 18.5 | 35 |
| 22 | 41 |
| 30 | 55 |
| 37 | 66 |

MSPs for motor protection

Setting range for thermal overload release CLASS 10

| [A] | Article No. |
|---------|--------------|
| 28 – 36 | 3RV203-4PA10 |
| 32 – 40 | 3RV203-4UA10 |
| 35 – 45 | 3RV203-4VA10 |
| 42 – 52 | 3RV203-4WA10 |
| 49 – 59 | 3RV203-4XA10 |
| 54 – 65 | 3RV203-4JA10 |
| 62 – 73 | 3RV203-4KA10 |
| 70 – 80 | 3RV203-4RA10 |

Soft starter with overload prot.

| Rated operational current [A] | Article No. |
|-------------------------------|---------------|
| 45 | 3RW4036-1BB-4 |
| 63 | 3RW4037-1BB-4 |
| 72 | 3RW4038-1BB-4 |

Current monitoring relays

| Meas. range [A] | Article No. Basic (analog adjustable) | Article No. Standard (digital adjustable)* |
|-----------------|---------------------------------------|--|
| 8 – 80 | 3RR2143-□A□30 | 3RR2243-□F□30 |

Standard switching capacity 65 kA at 400 V: ①
 Increased switching capacity 100 kA at 400 V: ②

24 V AC/DC: ①
 110 – 230 V AC/DC: ②

Screw terminals: ① 24 V AC/DC: ②
 Spring-loaded terminals in auxiliary circuit: ③ 110 – 230 V AC/DC: ④

*likewise available as 3RR24 with IO-Link

Fuseless assembly

Size S3 up to 55 kW

Motor starter protector for starter protection, contactor with overload relay

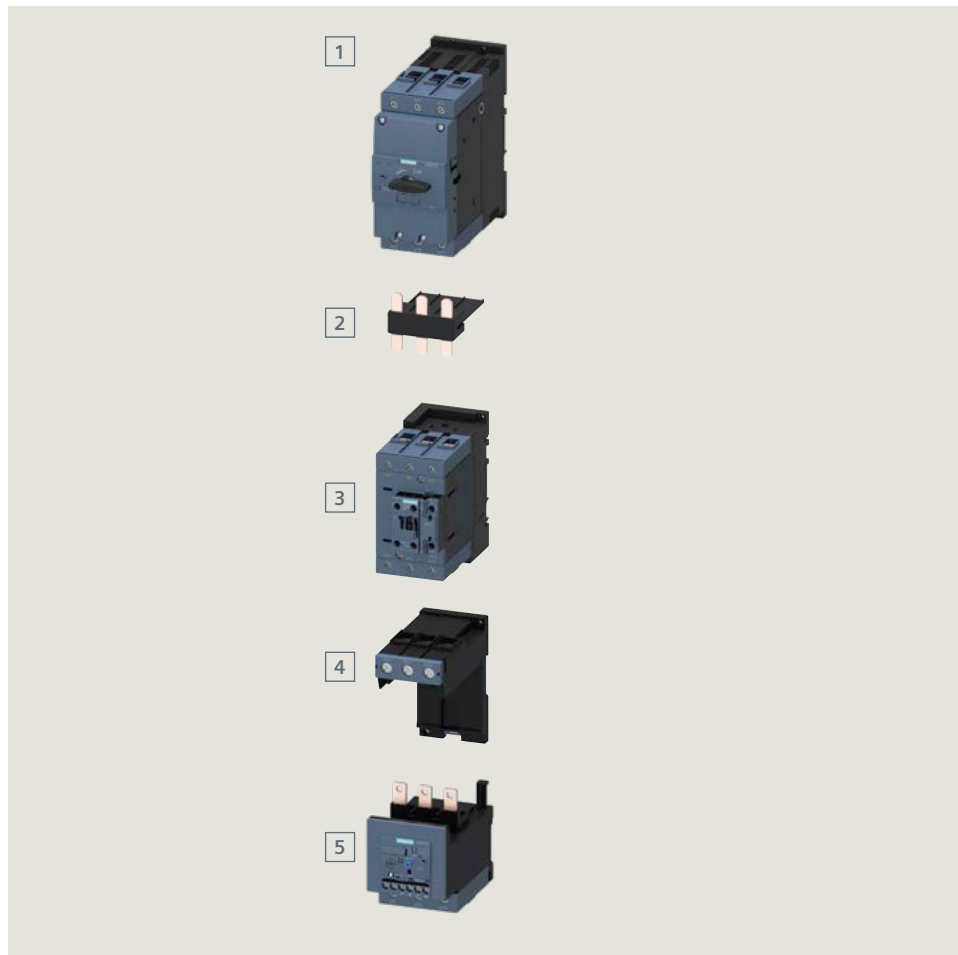

| Type | Screw terminals |
|---|------------------------------|
| 1 Motor starter protector | 3RV234-□-□□□1□ |
| 2 Link module ¹⁾ | 3RA1941-1AA00 |
| 3 Contactor | 3RT204-□-□□□□□ |
| 4 Terminal support for stand-alone installation | 3RU2946-3AA01 |
| 5 Overload relay | 3RU2146-□□B0 or 3RB3□4□-□□B0 |

¹⁾ Installation with link module only allowable on standard mounting rail adapter.

Motor starter protectors for motor protection, contactor and overload relay

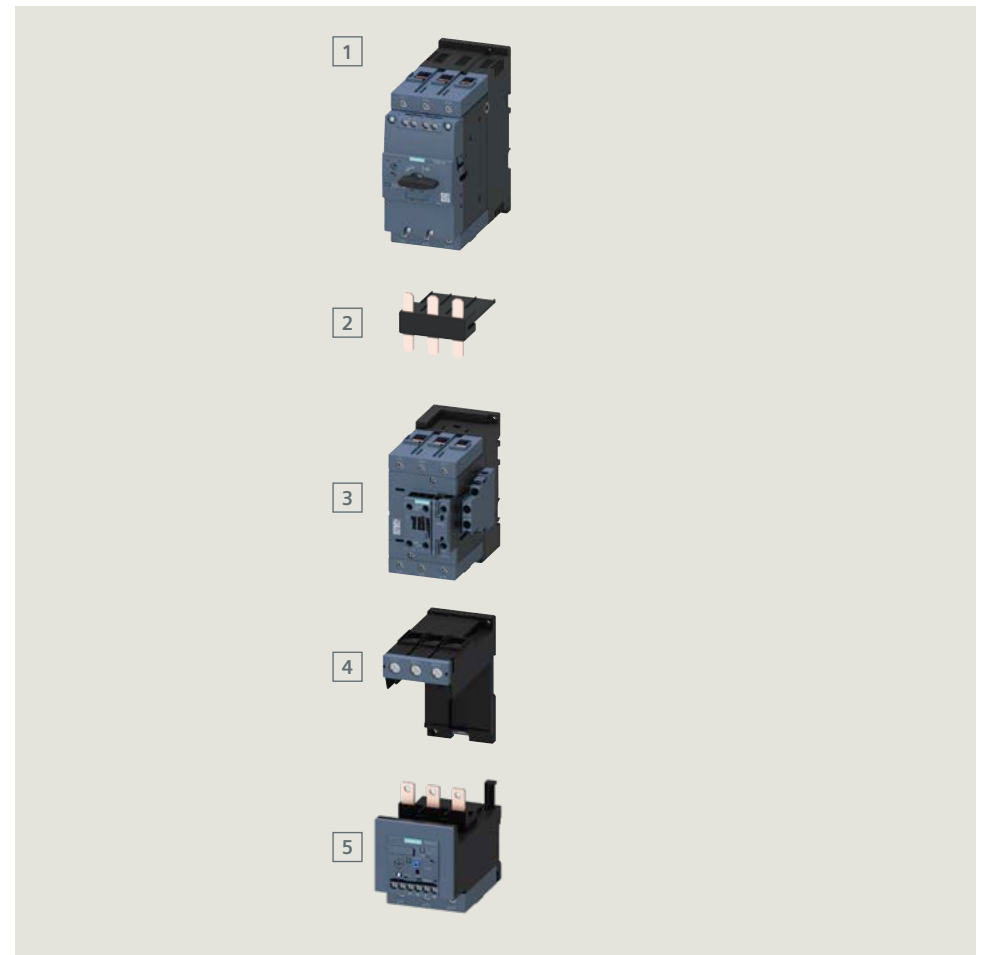

| Type | Screw terminals |
|---|------------------------------|
| 1 Motor starter protector | 3RV204-□-□□□1□ |
| 2 Link module ¹⁾ | 3RA1941-1AA00 |
| 3 Contactor | 3RT204-□-□□□□□ |
| 4 Terminal support for stand-alone installation | 3RU2946-3AA01 |
| 5 Overload relay | 3RU2146-□□B0 or 3RB3□4□-□□B0 |

¹⁾ Installation with link module only allowable on standard mounting rail adapter.

Starter combinations in size S3: Motor starter protector for motor protection and contactor

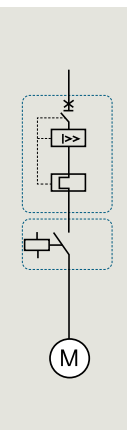

| Standard three-phase motor 4-pole at 400 V AC | |
|---|-----|
| [kW] | [A] |
| 37 | 66 |
| 45 | 80 |
| 55 | 97 |



Motor starter protector

Setting range for thermal overload release CLASS 10

| [A] | Article No. |
|----------|--------------|
| 36 – 50 | 3RV204-4HA10 |
| 45 – 63 | 3RV204-4JA10 |
| 57 – 75 | 3RV204-4KA10 |
| 65 – 84 | 3RV204-4RA10 |
| 75 – 93 | 3RV204-4YA10 |
| 80 – 100 | 3RV204-4MA10 |

3 VA



Contactors

| Rated operational current [A] | Article No. 230 V AC, 50 Hz | Article No. 50/60 Hz AC/DC |
|-------------------------------|-----------------------------|----------------------------|
| 80 | 3RT2045-AP00 | 3RT2045-N30 |
| 95 | 3RT2046-AP00 | 3RT2046-N30 |
| 110 | 3RT2047-AP00 | 3RT2047-N30 |

Standard switching capacity 65 kA at 400 V:

Increased switching capacity 100 kA at 400 V:

Screw terminals: 20 – 33 V AC/DC:

Spring-loaded terminals in auxiliary circuit: 83 – 155 V AC/DC:

175 – 280 V AC/DC:

Starter combinations in size S3: Motor starter protector for starter protection, contactor with overload relay

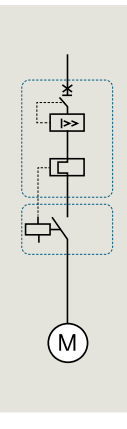

| Standard three-phase motor 4-pole at 400 V AC | |
|---|-----|
| [kW] | [A] |
| 37 | 66 |
| 45 | 80 |
| 55 | 97 |

Motor starter protector

| MSP rated current [A] | Article No. |
|-----------------------|--------------|
| 50 | 3RV234-4HC10 |
| 63 | 3RV234-4JC10 |
| 75 | 3RV234-4KC10 |
| 84 | 3RV234-4RC10 |
| 93 | 3RV234-4YC10 |
| 100 | 3RV234-4MC10 |

3 VA

Contactors

| Rated operational current [A] | Article No. 230 V AC, 50 Hz | Article No. 50/60 Hz AC/DC |
|-------------------------------|-----------------------------|----------------------------|
| 80 | 3RT2045-AP00 | 3RT2045-N30 |
| 95 | 3RT2046-AP00 | 3RT2046-N30 |
| 110 | 3RT2047-AP00 | 3RT2047-N30 |

Overload relay

| Setting range CLASS 10 [A] | Article No. thermal overload relay | Setting range CLASS 10E [A] | Article No. electrical overload relay |
|----------------------------|------------------------------------|-----------------------------|---------------------------------------|
| 36 – 50 | 3RU2146-4HB0 | 32 – 115 | 3RB3046-1X□□ |
| 45 – 63 | 3RU2146-4JB0 | | |
| 57 – 75 | 3RU2146-4KB0 | | |
| 70 – 90 | 3RU2146-4LB0 | | |
| 80 – 100 | 3RU2146-4MB0 | | |

Standard switching capacity 65 kA at 400 V:

Increased switching capacity 100 kA at 400 V:

Screw terminals: 20 – 33 V AC/DC:

Spring-loaded terminals in auxiliary circuit: 83 – 155 V AC/DC:

175 – 280 V AC/DC:

Screw terminals in auxiliary circuit:

Spring-loaded terminals in auxiliary circuit:

Straight-through transformer, screw terminals in auxiliary circuit:

Straight-through transformer, spring-loaded terminals in auxiliary circuit:

For mounting onto contactor main circuit:

Stand-alone installation:

Fuseless assembly

Size S3 up to 55 kW

Motor starter protector for motor protection, 3RW30 soft starter without overload protection

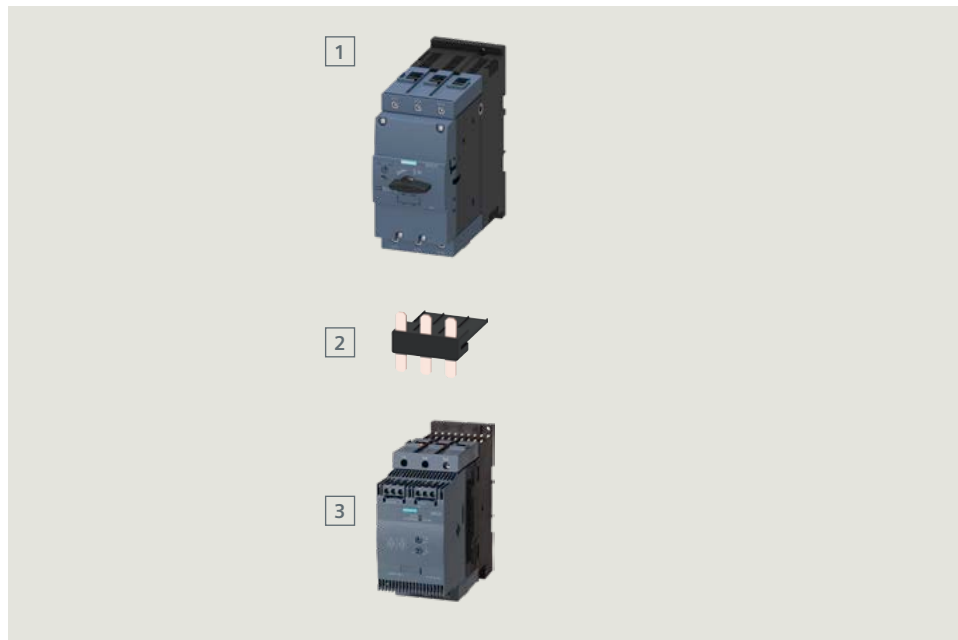

| Type | Screw terminals |
|-----------------------------|-----------------|
| 1 Motor starter protector | 3RV204□-□□□1□ |
| 2 Link module ¹⁾ | 3RA1941-1AA00 |
| 3 Soft starter | 3RW304□-1□□□□ |

¹⁾ Installation with link module only allowable on mounting plate.

Motor starter protector for motor protection, 3RW40 soft starter with overload protection

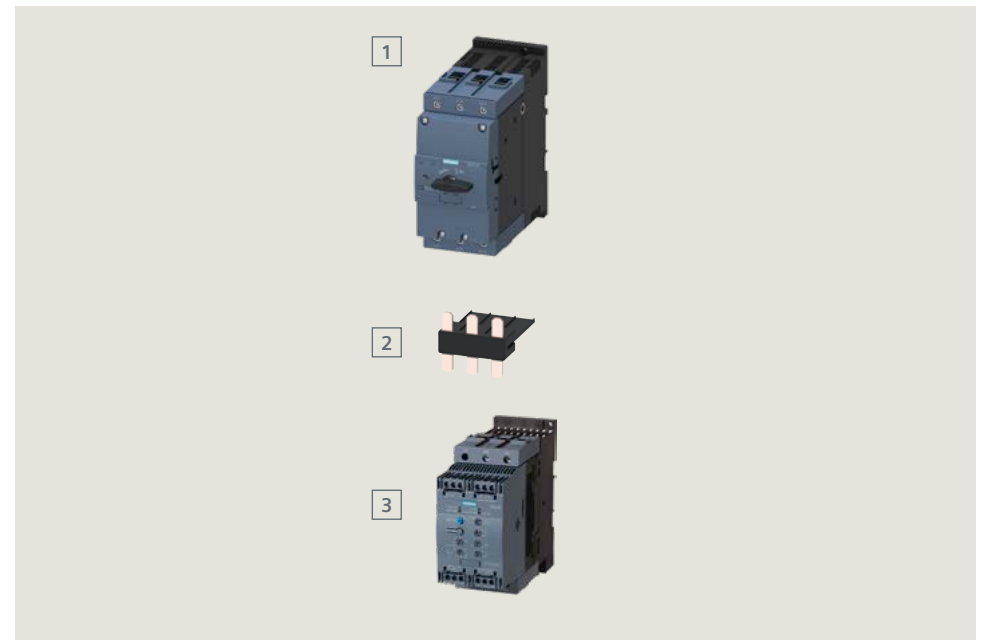

| Type | Screw terminals |
|-----------------------------|-----------------|
| 1 Motor starter protector | 3RV204□-□□□1□ |
| 2 Link module ¹⁾ | 3RA1941-1AA00 |
| 3 Soft starter | 3RW404□-1□□□□ |

Starter combinations in size S3: Motor starter protector for motor protection and 3RW30 soft starter without overload protection

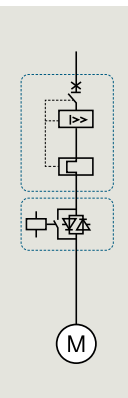

| Standard three-phase motor 4-pole at 400 V AC | |
|---|-----|
| [kW] | [A] |
| 37 | 66 |
| 45 | 80 |
| 55 | 97 |



Motor starter protector

Setting range for thermal overload release CLASS 10

| [A] | Article No. |
|----------|---------------|
| 36 – 50 | 3RV204□-4HA10 |
| 45 – 63 | 3RV204□-4JA10 |
| 57 – 75 | 3RV204□-4KA10 |
| 65 – 84 | 3RV204□-4RA10 |
| 75 – 93 | 3RV204□-4YA10 |
| 80 – 100 | 3RV204□-4MA10 |

3 VA



Soft starter

| Rated operational current [A] | Article No. |
|-------------------------------|---------------|
| 80 | 3RW3046-1BB□4 |
| 106 | 3RW3047-1BB□4 |

Standard switching capacity 65 kA at 400 V:

Increased switching capacity 100 kA at 400V:

24 V AC/DC:

110 – 230 V AC/DC:

Starter combinations in size S3: Motor starter protector for motor protection and 3RW40 soft starter with overload protection

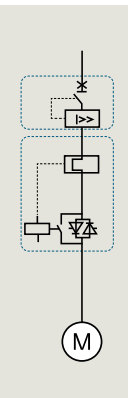

| Standard three-phase motor 4-pole at 400 V AC | |
|---|-----|
| [kW] | [A] |
| 37 | 66 |
| 45 | 80 |
| 55 | 97 |

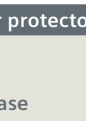

Motor starter protector

Setting range for thermal overload release CLASS 10

| [A] | Article No. |
|----------|---------------|
| 36 – 50 | 3RV204□-4HA10 |
| 45 – 63 | 3RV204□-4JA10 |
| 57 – 75 | 3RV204□-4KA10 |
| 65 – 84 | 3RV204□-4RA10 |
| 75 – 93 | 3RV204□-4YA10 |
| 80 – 100 | 3RV204□-4MA10 |

3 VA

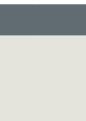

Soft starter

| Rated operational current [A] | Article No. |
|-------------------------------|---------------|
| 80 | 3RW4046-1BB□4 |
| 106 | 3RW4047-1BB□4 |

Standard switching capacity 65 kA at 400 V:

Increased switching capacity 100 kA at 400 V:

24 V AC/DC:

110 – 230 V AC/DC:

Selection and ordering data for fused feeders of sizes S6, S10, S12

Size S6



| Standard three-phase motor 4-pole at 400 V AC | | Contactors | | | | |
|---|-----|-------------------------------|---|----------------------------------|--|-------------------------------|
| | | Rated operational current [A] | Solenoid-operated mechanism | Control supply voltage [V AC/DC] | Article No. contactors | Article No. vacuum contactors |
| 55 | 97 | 115 | Conventional | 220 – 240 | 3RT1054-1AP36 | – |
| | | | Electronic – for 24 V DC PLC output – for 24 V DC PLC output, w. RLT ¹⁾ | 200 – 277 200 – 277 | 3RT1054-1NP36 3RT1054-1PP35 | – – |
| 75 | 132 | 150 | Conventional | 220 – 240 | 3RT1055-6AP36 | – |
| | | | Electronic – for 24 V DC PLC output – for 24 V DC PLC output, w. RLT ¹⁾ | 200 – 277 200 – 277 | 3RT1055-6NP36 3RT1055-6PP35 | – – |
| 90 | 160 | 185 | Conventional | 220 – 240 | 3RT1056-6AP36 | – |
| | | | Electronic – for 24 V DC PLC output – for 24 V DC PLC output, w. RLT ¹⁾ | 200 – 277 200 – 277 | 3RT1056-6NP36 3RT1056-6PP35 | – – |

¹⁾ RLT: remaining lifetime

²⁾ As 3RB2143 also available with another CLASS and other functions



| Overload relays | | |
|-------------------|--|-------------------------|
| Setting range [A] | Article No. electronic overload relay CLASS 10 | Version |
| 50 – 200 | 3RB2056-1FW2²⁾ | w. str.-through transf. |
| 50 – 200 | 3RB2056-1FC2²⁾ | w. busbar connection |



| Soft starter | | | |
|-------------------------------|--------------------------------|------------|----------------------|
| Operating power at 400 V [kW] | Operating current at 40 °C [A] | Frame Size | Article No. |
| 75 | 143 | S6 | 3RW5055-□□B□□ |
| 90 | 171 | S6 | 3RW5056-□□B□□ |

- Spring-type terminal
- Screw-type terminal
- Analog output
- Thermistor motor protection
- 24 V AC/DC
- 110–250 V AC
- 200–480 V
- 200–600 V

Size S10



| Standard three-phase motor 4-pole at 400 V AC | | Contactors | | | | | Overload relays | | | Soft starter | | | |
|---|-----|-------------------------------|---|----------------------------------|--------------------------------|-------------------------------|-------------------|--|------------------------|-------------------------------|--------------------------------|------------|---------------|
| | | Rated operational current [A] | Solenoid-operated mechanism | Control supply voltage [V AC/DC] | Article No. contactors | Article No. vacuum contactors | Setting range [A] | Article No. electronic overload relay CLASS 10 | Version | Operating power at 400 V [kW] | Operating current at 40 °C [A] | Frame Size | Article No. |
| 110 | 195 | 225 | Conventional | 220 – 240 | 3RT1064-6AP36 | 3RT1264-6AP36 | 55 – 250 | 3RB2066-1GC2 ²⁾ | with busbar connection | 110 | 210 | S12 | 3RW5072-□□B□□ |
| | | | Electronic – for 24 V DC PLC output – for 24 V DC PLC output, w. RLT ¹⁾ | 200 – 277 200 – 277 | 3RT1064-6NP36 3RT1064-6PP35 | 3RT1264-6NP36 – | | | | | | | |
| 132 | 230 | 265 | Conventional | 220 – 240 | 3RT1065-6AP36 | 3RT1265-6AP36 | 160 – 630 | 3RB2066-1MC2 ²⁾ | with busbar connection | | | | |
| | | | Electronic – for 24 V DC PLC output – for 24 V DC PLC output, w. RLT ¹⁾ | 200 – 277 200 – 277 | 3RT1065-6NP36 3RT1065-6PP35 | 3RT1265-6NP36 – | | | | | | | |
| 160 | 280 | 300 | Conventional | 220 – 240 | 3RT1066-6AP36 | 3RT1266-6AP36 | | | | 160 | 315 | S12 | 3RW5074-□□B□□ |
| | | | Electronic – for 24 V DC PLC output – for 24 V DC PLC output, w. RLT ¹⁾ | 200 – 277 200 – 277 | 3RT1066-6NP36 3RT1066-6PP35 | 3RT1266-6NP36 – | | | | | | | |

¹⁾ RLT: remaining lifetime signal

²⁾ As 3RB2163 also available with another CLASS and further functions

▲▲▲▲▲
 Spring-type terminal 2
 Screw-type terminal 6
 Analog output A
 Thermistor motor protection T
 24 V AC/DC 0
 110–250 V AC 1
 200–480 V 4
 200–600 V 5

* Frame Size S12

Selection and ordering data for fused feeders of sizes S6, S10, S12

Size S12



| Standard three-phase motor 4-pole at 400 V AC | | Contactors | | | | | Overload relays ¹⁾ | | | Soft starter | | | |
|---|-----|-------------------------------|---|----------------------------------|--------------------------------|-------------------------------|-------------------------------|--|------------------------|-------------------------------|--------------------------------|------------|---------------|
| | | Rated operational current [A] | Solenoid-operated mechanism | Control supply voltage [V AC/DC] | Article No. contactors | Article No. vacuum contactors | Setting range [A] | Article No. electronic overload relay CLASS 10 | Version | Operating power at 400 V [kW] | Operating current at 40 °C [A] | Frame Size | Article No. |
| 200 | 350 | 400 | Conventional | 220 – 240 | 3RT1075-6AP36 | 3RT1275-6AP36 | 160 – 630 | 3RB2066-1MC2 ³⁾ | with busbar connection | 200 | 370 | S12 | 3RW5075-□□B□□ |
| | | | Electronic – for 24 V DC PLC output – for 24 V DC PLC output, w. RLT ²⁾ | 200 – 277 200 – 277 | 3RT1075-6NP36 3RT1075-6PP35 | 3RT1275-6NP36 – | | | | 250 | 470 | S12 | 3RW5076-□□B□□ |
| 250 | 430 | 500 | Conventional | 220 – 240 | 3RT1076-6AP36 | 3RT1276-6AP36 | | | | 315 | 570 | S12 | 3RW5077-□□B□□ |
| 315 | | | Electronic – for 24 V DC PLC output – for 24 V DC PLC output, w. RLT ²⁾ | 200 – 277 200 – 277 | 3RT1076-6NP36 3RT1076-6PP35 | 3RT1276-6NP36 – | | | | | | | |

For applications over 100 A, SIRIUS contactors can be combined with SENTRON 3VL circuit breakers. For more detailed information, please refer to the configuration document "Configuring SIRIUS load feeders in fuseless design".

¹⁾ When using trip CLASS 20, refer to the notes in the project planning aid "Configuring SIRIUS fuseless load feeders" and in the catalog
²⁾ RLT: remaining lifetime signal
³⁾ As 3RB2163 also available with another CLASS and further functions

Spring-type terminal 2
Screw-type terminal 6
Analog output A
Thermistor motor protection T
24 V AC/DC 0
110–250 V AC 1
200–480 V 4
200–600 V 5

SENTRON 3VA circuit breakers are suitable for fuseless short-circuit and overload protection of soft starters from size S6. For more detailed information, please refer to the catalog.

Fuseless load feeders up to 15 kW

Standard three-phase motor 4-pole at 400 V AC

| [kW] | [A] |
|------|------|
| 0.06 | 0.20 |
| 0.06 | 0.20 |
| 0.09 | 0.30 |
| 0.09 | 0.30 |
| 0.12 | 0.44 |
| 0.18 | 0.60 |
| 0.18 | 0.60 |
| 0.25 | 0.85 |
| 0.37 | 1.10 |
| 0.55 | 1.50 |
| 0.75 | 1.90 |
| 0.75 | 1.90 |
| 1.1 | 2.07 |
| 1.5 | 3.60 |
| 1.5 | 3.60 |
| 2.2 | 4.90 |
| 3 | 6.50 |
| 4 | 8.50 |
| 5.5 | 11.5 |
| 7.5 | 15.5 |
| 7.5 | 15.5 |
| 11 | 22 |
| 11 | 22 |
| 15 | 29 |
| 15 | 29 |



3RA21 direct-on-line starters

Setting range for thermal overload release

| [A] | Type of coordination "2" at I _q = 150 kA at 400 V |
|-------------|--|
| 0.14 – 0.2 | 3RA2110-0B □ 15-1 □ □ □ S00 |
| 0.18 – 0.25 | 3RA2110-0C □ 15-1 □ □ □ S00 |
| 0.22 – 0.32 | 3RA2110-0D □ 15-1 □ □ □ S00 |
| 0.28 – 0.4 | 3RA2110-0E □ 15-1 □ □ □ S00 |
| 0.35 – 0.5 | 3RA2110-0F □ 15-1 □ □ □ S00 |
| 0.45 – 0.63 | 3RA2110-0G □ 15-1 □ □ □ S00 |
| 0.55 – 0.8 | 3RA2110-0H □ 15-1 □ □ □ S00 |
| 0.7 – 1 | 3RA2110-0J □ 15-1 □ □ □ S00 |
| 0.9 – 1.25 | 3RA2110-0K □ 15-1 □ □ □ S00 |
| 1.1 – 1.6 | 3RA2110-1A □ 15-1 □ □ □ S00 |
| 1.4 – 2 | 3RA2110-1B □ 15-1 □ □ □ S00 |
| 1.8 – 2.5 | 3RA2110-1C □ 15-1 □ □ □ S00 |
| 2.2 – 3.2 | 3RA2110-1D □ 15-1 □ □ □ S00 |
| 2.8 – 4 | 3RA2110-1E □ 15-1 □ □ □ S00 |

| | |
|-----------|----------------------------|
| 3.5 – 5 | 3RA2120-1F □ 24-0 □ □ □ S0 |
| 4.5 – 6.3 | 3RA2120-1G □ 24-0 □ □ □ S0 |
| 5.5 – 8 | 3RA2120-1H □ 24-0 □ □ □ S0 |
| 7 – 10 | 3RA2120-1J □ 24-0 □ □ □ S0 |
| 9 – 12.5 | 3RA2120-1K □ 24-0 □ □ □ S0 |
| 10 – 16 | 3RA2120-4A □ 26-0 □ □ □ S0 |
| 13 – 20 | 3RA2120-4B □ 27-0 □ □ □ S0 |
| 16 – 22 | 3RA2120-4C □ 27-0 □ □ □ S0 |
| 18 – 25 | 3RA2120-4D □ 27-0 □ □ □ S0 |
| 23 – 28 | 3RA2120-4N □ 27-0 □ □ □ S0 |
| 27 – 32 | 3RA2120-4E □ 27-0 □ □ □ S0 |

Screw terminals (standard rail mounting): **A**
 Spring-loaded terminals (standard rail mounting): **E**
 Screw terminals (busbar adapter): **D**
 Spring-loaded terminals (busbar adapter): **H**
 24 V DC: **B** **B** **4**
 230 V AC: **A** **P** **0**



3RA61 compact starters

Setting range for thermal overload release

| [A] | |
|-------------|-------------------|
| 0.1 – 0.4 | 3RA6120-□ A □ 3 □ |
| 0.32 – 1.25 | 3RA6120-□ B □ 3 □ |
| 1 – 4 | 3RA6120-□ C □ 3 □ |
| 3 – 12 | 3RA6120-□ D □ 3 □ |
| 8 – 32 | 3RA6120-□ E □ 3 □ |

Without terminals: **0** **0**
 With screw terminals: **1** **2**
 With spring-loaded terminals: **2** **2**
 24 V AC/DC: **B**
 110 – 240 V AC/DC: **P**



SIRIUS 3RM1 motor starters

Setting range for thermal overload release

| [A] | |
|-------------------|--------------------|
| 0.1 – 0.5 | 3RM1 □ 01 □ AA □ 4 |
| 0.4 – 2.0 | 3RM1 □ 02 □ AA □ 4 |
| 1.6 – 7.0 (10 A)* | 3RM1 □ 07 □ AA □ 4 |

Direct-on-line starter **0**
 Failsafe direct-on-line starter **1**
 Screw terminals: **1**
 Spring-loaded terminals: **2**
 Mixed connection method: **3**
 24 V DC Us **0**
 110 – 230 V AC; 110 V DC Us **1**

*Operation of resistive loads with maximum 10 A

Note: The 3RM1 motor starters do not have integral short-circuit protection. They can be used very effectively in combination with SIRIUS motor starter protectors in group assemblies, for example.

Fuseless load feeders up to 15 kW



Standard three-phase motor 4-pole at 400 V AC

| [kW] | [A] |
|------|------|
| 0.06 | 0.20 |
| 0.06 | 0.20 |
| 0.09 | 0.30 |
| 0.09 | 0.30 |
| 0.12 | 0.44 |
| 0.18 | 0.60 |
| 0.18 | 0.60 |
| 0.25 | 0.85 |
| 0.37 | 1.10 |
| 0.55 | 1.50 |
| 0.75 | 1.90 |
| 0.75 | 1.90 |
| 1.1 | 2.70 |
| 1.5 | 3.60 |
| 1.5 | 3.60 |
| 2.2 | 4.90 |
| 3 | 6.50 |
| 4 | 8.50 |
| 5.5 | 11.5 |
| 7.5 | 15.5 |
| 7.5 | 15.5 |
| 11 | 22 |
| 11 | 22 |
| 15 | 29 |
| 15 | 29 |

3RA22 reversing starters

| Setting range for thermal overload release [A] | Type of coordination "2" at I _q = 150 kA at 400 V |
|--|--|
| 0.14 – 0.2 | 3RA2210-0B □ 15-2 □ □ □ S00 |
| 0.18 – 0.25 | 3RA2210-0C □ 15-2 □ □ □ S00 |
| 0.22 – 0.32 | 3RA2210-0D □ 15-2 □ □ □ S00 |
| 0.28 – 0.4 | 3RA2210-0E □ 15-2 □ □ □ S00 |
| 0.35 – 0.5 | 3RA2210-0F □ 15-2 □ □ □ S00 |
| 0.45 – 0.63 | 3RA2210-0G □ 15-2 □ □ □ S00 |
| 0.55 – 0.8 | 3RA2210-0H □ 15-2 □ □ □ S00 |
| 0.7 – 1 | 3RA2210-0J □ 15-2 □ □ □ S00 |
| 0.9 – 1.25 | 3RA2210-0K □ 15-2 □ □ □ S00 |
| 1.1 – 1.6 | 3RA2210-1A □ 15-2 □ □ □ S00 |
| 1.4 – 2 | 3RA2210-1B □ 15-2 □ □ □ S00 |
| 1.8 – 2.5 | 3RA2210-1C □ 15-2 □ □ □ S00 |
| 2.2 – 3.2 | 3RA2210-1D □ 15-2 □ □ □ S00 |
| 2.8 – 4 | 3RA2210-1E □ 15-2 □ □ □ S00 |
| 3.5 – 5 | 3RA2220-1F □ 24-0 □ □ □ S0 |
| 4.5 – 6.3 | 3RA2220-1G □ 24-0 □ □ □ S0 |
| 5.5 – 8 | 3RA2220-1H □ 24-0 □ □ □ S0 |
| 7 – 10 | 3RA2220-1J □ 24-0 □ □ □ S0 |
| 9 – 12.5 | 3RA2220-1K □ 24-0 □ □ □ S0 |
| 10 – 16 | 3RA2220-4A □ 26-0 □ □ □ S0 |
| 13 – 20 | 3RA2220-4B □ 27-0 □ □ □ S0 |
| 16 – 22 | 3RA2220-4C □ 27-0 □ □ □ S0 |
| 18 – 25 | 3RA2220-4D □ 27-0 □ □ □ S0 |
| 23 – 28 | 3RA2220-4N □ 27-0 □ □ □ S0 |
| 27 – 32 | 3RA2220-4E □ 27-0 □ □ □ S0 |

- Screw terminals (standard rail mounting) S00: **A**
- Screw terminals (standard rail mounting) S0: **B**
- Spring-loaded terminals (standard rail mounting) S00: **E**
- Spring-loaded terminals (standard rail mounting) S0: **F**
- Screw terminals (busbar adapter): **D**
- Spring-loaded terminals (busbar adapter): **H**
- 24 V DC: **B B 4**
- 230 V AC: **A P 0**



3RA62 compact starters

| Setting range for thermal overload release [A] | |
|--|-------------------|
| 0.1 – 0.4 | 3RA6250-□ A □ 3 □ |
| 0.32 – 1.25 | 3RA6250-□ B □ 3 □ |
| 1 – 4 | 3RA6250-□ C □ 3 □ |
| 3 – 12 | 3RA6250-□ D □ 3 □ |
| 8 – 32 | 3RA6250-□ E □ 3 □ |

- Without terminals: **0** **0**
- With screw terminals: **1** **2**
- With spring-loaded terminals: **2** **2**
- 24 V AC/DC: **B**
- 110 – 240 V AC/DC: **P**



SIRIUS 3RM1 motor starters

| Setting range for thermal overload release [A] | |
|--|--------------------|
| 0.1 – 0.5 | 3RM1 □ 01 □ AA □ 4 |
| 0.4 – 2.0 | 3RM1 □ 02 □ AA □ 4 |
| 1.6 – 7.0 (10 A)* | 3RM1 □ 07 □ AA □ 4 |

- Direct-on-line starter **2**
- Failsafe direct-on-line starter **3**
- Screw terminals: **1**
- Spring-loaded terminals: **2**
- Mixed connection method: **3**
- 24 V DC Us **0**
- 110 – 230 V AC; 110 V DC Us **1**

*Operation of resistive loads with maximum 10 A

Note: The 3RM1 motor starters do not have integral short-circuit protection. They can be used very effectively in combination with SIRIUS motor starter protectors in group assemblies, for example.

Function modules for IO-Link or AS-i that are mounted on contactors (24 V DC) with communication interface are required for connecting the load feeders to the controller. Depending on the version, these communicate with an IO-Link interface group or any AS-i master. Alternatively, the contactors can be connected to the controller via IO-Link and by means of the 3RB24 overload relay. The 3RR24 current monitoring relays serve to provide optimum current monitoring of the overall system or the driven process.

Typical configuration in the environment of IO-Link

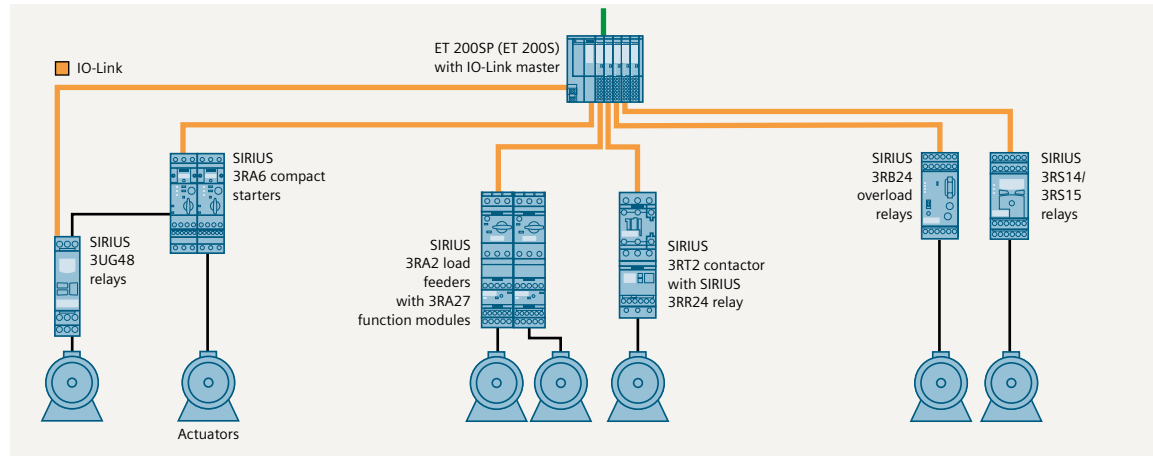

Typical configuration in the environment of AS-Interface

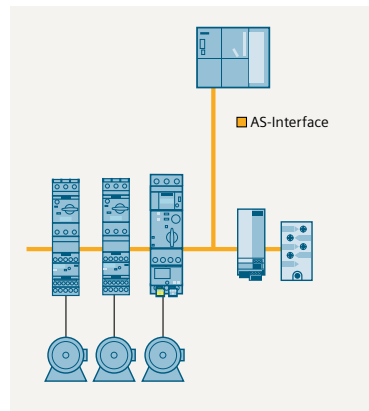

| AS-Interface | |
|---|-----------------------------------|
| Version | Article No. |
| CP343-2P communications processor for connecting SIMATIC S7-300 to AS-Interface (AS-i Spec.3.0) for up to 62 load feeders | 6GK7343-2AH11-0XA0 |
| Front connector 20-pin, with screw-type contacts | 6ES7392-1AJ00-0AA0 |
| Front connector 20-pin, with spring-loaded contacts | 6ES7392-1BJ00-0AA0 |
| DP/AS-i LINK Advanced, gateway between PROFIBUS DP and AS-Interface | |
| – Single master for up to 62 load feeders | 6GK1415-2BA10 |
| – Double master for up to 124 load feeders | 6GK1415-2BA20 |
| AS-Interface power supply unit IP20 | |
| – 120/230 V AC 3 A | 3RX9501-0BA00 |
| – 24 V DC 3 A | 3RX9501-1BA00 |
| – 120/230 V AC 5 A | 3RX9502-0BA00 |
| – 120/230 V AC 8 A | 3RX9503-0BA00 |
| Further system components for AS-Interface | See Industry Mall or Catalog IKPI |

| Three-phase motor 400 V [kW] | Rated operational current contactor [A] |
|------------------------------|---|
| 3 | 7 |
| 4 | 9 |
| 5.5 | 12 |
| 7.5 | 16 |
| 5.5 | 12 |
| 7.5 | 16 |
| 11 | 25 |
| 15 | 32 |
| 18.5 | 38 |

| Contactors S00 with communication interface | |
|---|---|
| Aux. contacts | Control supply voltage Article No. DC 24 V |
| 1NC | 3RT2015-□BB42-0CCO |
| 1NO | 3RT2015-□BB41-0CCO |
| 1NC | 3RT2016-□BB42-0CCO |
| 1NO | 3RT2016-□BB41-0CCO |
| 1NC | 3RT2017-□BB42-0CCO |
| 1NO | 3RT2017-□BB41-0CCO |
| 1NC | 3RT2018-□BB42-0CCO |
| 1NO | 3RT2018-□BB41-0CCO |

| Contactors S0 with communication interface | |
|--|---|
| Aux. contacts | Control supply voltage Article No. DC 24 V |
| 1NO + 1NC | 3RT2024-□BB40-0CCO |
| 1NO + 1NC | 3RT2025-□BB40-0CCO |
| 1NO + 1NC | 3RT2026-□BB40-0CCO |
| 1NO + 1NC | 3RT2027-□BB40-0CCO |
| 1NO + 1NC | 3RT2028-□BB40-0CCO |

▲ Screw terminals: ①
Spring-loaded terminals S00/S0: ②

| | |
|------|----|
| 18.5 | 40 |
| 22 | 50 |
| 30 | 65 |
| 37 | 80 |

| Contactors S2 with communication interface | |
|--|---|
| Aux. contacts | Control supply voltage Article No. DC 24 V |
| 1NO + 1NC | 3RT2035-□NB30-0CCO |
| 1NO + 1NC | 3RT2036-□NB30-0CCO |
| 1NO + 1NC | 3RT2037-□NB30-0CCO |
| 1NO + 1NC | 3RT2038-□NB30-0CCO |

▲ Screw terminals: ①
Spring-loaded terminals in auxiliary circuit: ③

| | |
|----|-----|
| 37 | 80 |
| 45 | 95 |
| 55 | 110 |

| Contactors S3 with communication interface | |
|--|---|
| Aux. contacts | Control supply voltage Article No. DC 24 V |
| 1NO + 1NC | 3RT2045-□NB30-0CCO |
| 1NO + 1NC | 3RT2046-□NB30-0CCO |
| 1NO + 1NC | 3RT2047-□NB30-0CCO |

▲ Screw terminals: ①
Spring-loaded terminals in auxiliary circuit: ③

Function modules for mounting on 3RT2 contactors and for connecting to the automation level

Parallel wiring



Direct-on-line starter with time-delay relay

| Article No. | | |
|----------------------------------|--------------------------|--|
| ON-delay | S00/S0 S2/S3 S2/S3 | 3RA2811- <input type="checkbox"/> CW10 3RA2831- <input type="checkbox"/> DG10 3RA2831- <input type="checkbox"/> DH10 |
| OFF-delay (with aux. voltage) | S00/S0 S2/S3 S2/S3 | 3RA2812- <input type="checkbox"/> CW10 3RA2832- <input type="checkbox"/> DG10 3RA2832- <input type="checkbox"/> DH10 |



Reversing starter kits

| Article No. | | |
|----------------------------|-----|--------------------------------------|
| Wiring kits for contactors | S00 | 3RA2913-2AA <input type="checkbox"/> |
| Wiring kits for contactors | S0 | 3RA2923-2AA <input type="checkbox"/> |
| Wiring kits for contactors | S2 | 3RA2933-2AA <input type="checkbox"/> |
| Wiring kits for contactors | S3 | 3RA2943-2AA <input type="checkbox"/> |



Star-delta (wye-delta) starter^{1) 2) 4)}

| Article No. | | |
|----------------------------|-----|--------------------------------------|
| Function module | | 3RA2816-0EW20 |
| Wiring kits for contactors | S00 | 3RA2913-2BB <input type="checkbox"/> |
| Wiring kits for contactors | S0 | 3RA2923-2BB <input type="checkbox"/> |
| Wiring kits for contactors | S2 | 3RA2933-2BB <input type="checkbox"/> |
| Wiring kits for contactors | S3 | 3RA2943-2BB <input type="checkbox"/> |

IO-Link



IO-Link connection for direct-on-line starter^{1) 2)}

| Article No. | |
|-----------------|--|
| Function module | 3RA2711- <input type="checkbox"/> AA00 |



IO-Link connection for reversing starter^{1) 2) 3)}

| Article No. | | |
|----------------------------|-----|--|
| Function module | | 3RA2711- <input type="checkbox"/> BA00 |
| Wiring kits for contactors | S00 | 3RA2913-2AA <input type="checkbox"/> |
| Wiring kits for contactors | S0 | 3RA2923-2AA <input type="checkbox"/> |
| Wiring kits for contactors | S2 | 3RA2933-2AA <input type="checkbox"/> |
| Wiring kits for contactors | S3 | 3RA2943-2AA <input type="checkbox"/> |



IO-Link connection for star-delta (wye-delta) combinations^{1) 2) 4)}

| Article No. | | |
|----------------------------|-----|--|
| Function module | | 3RA2711- <input type="checkbox"/> CA00 |
| Wiring kits for contactors | S00 | 3RA2913-2BB <input type="checkbox"/> |
| Wiring kits for contactors | S0 | 3RA2923-2BB <input type="checkbox"/> |
| Wiring kits for contactors | S2 | 3RA2933-2BB <input type="checkbox"/> |
| Wiring kits for contactors | S3 | 3RA2943-2BB <input type="checkbox"/> |

AS-Interface



AS-Interface connection for direct-on-line starter^{1) 2)}

| Article No. | |
|-----------------|--|
| Function module | 3RA2712- <input type="checkbox"/> AA00 |



AS-Interface connection for reversing starter^{1) 2) 3)}

| Article No. | | |
|----------------------------|-----|--|
| Function module | | 3RA2712- <input type="checkbox"/> BA00 |
| Wiring kits for contactors | S00 | 3RA2913-2AA <input type="checkbox"/> |
| Wiring kits for contactors | S0 | 3RA2923-2AA <input type="checkbox"/> |
| Wiring kits for contactors | S2 | 3RA2933-2AA <input type="checkbox"/> |
| Wiring kits for contactors | S3 | 3RA2943-2AA <input type="checkbox"/> |



AS-Interface connection for star-delta (wye-delta) combinations^{1) 2) 4)}

| Article No. | | |
|----------------------------|-----|--|
| Function module | | 3RA2712- <input type="checkbox"/> CA00 |
| Wiring kits for contactors | S00 | 3RA2913-2BB <input type="checkbox"/> |
| Wiring kits for contactors | S0 | 3RA2923-2BB <input type="checkbox"/> |
| Wiring kits for contactors | S2 | 3RA2933-2BB <input type="checkbox"/> |
| Wiring kits for contactors | S3 | 3RA2943-2BB <input type="checkbox"/> |

Screw terminals: ①
Spring-loaded terminals: ②

Screw terminals: ①
Spring-loaded terminals: ②

Screw terminals: ①
Spring-loaded terminals: ②

The contactor assemblies represented above can be combined with motor starter protectors, overload relays, and monitoring relays

¹⁾ The wiring modules for the control circuit are not required ²⁾ The contactor with basic module must be implemented as a communication contactor

³⁾ Comprising 1 basic module and 1 coupling module ⁴⁾ Comprising 1 basic module and 2 coupling modules

IO-Link

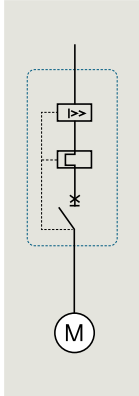

| Setting range for electronic overload release [A] | 3RA64 direct-on-line starter | 3RA65 reversing starter |
|---|------------------------------|-------------------------|
| | CPS ¹⁾ | CPS ¹⁾ |
| 0.1 – 0.4 | 3RA6400- □ AB42 | 3RA6500- □ AB42 |
| 0.32 – 1.25 | 3RA6400- □ BB42 | 3RA6500- □ BB42 |
| 1 – 4 | 3RA6400- □ CB42 | 3RA6500- □ CB42 |
| 3 – 12 | 3RA6400- □ DB42 | 3RA6500- □ DB42 |
| 8 – 32 | 3RA6400- □ EB42 | 3RA6500- □ EB42 |

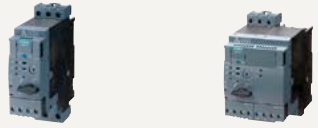

| Accessories for compact starter with IO-Link, 3RA27 function modules and 3RB24 overload relays with IO-Link | |
|---|---------------|
| Module connector, 14-pole, 8 cm, for 1 space between two contactors | 3RA2711-0EE02 |
| Module connector, 14-pole, 21 cm, for diverse space combinations between two contactors | 3RA2711-0EE03 |
| Operator panel (incl. enabling module and interface cover) | 3RA6935-0A |
| Connecting cable for operator panel | 3RA6933-0A |



AS-Interface

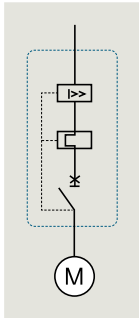

| Setting range for electronic overload release [A] | 3RA61 direct-on-line starter | 3RA62 reversing starter |
|---|------------------------------|-------------------------|
| | CPS ¹⁾ | CPS ¹⁾ |
| 0.1 – 0.4 | 3RA6120- □ AB34 | 3RA6250- □ AB34 |
| 0.32 – 1.25 | 3RA6120- □ BB34 | 3RA6250- □ BB34 |
| 1 – 4 | 3RA6120- □ CB34 | 3RA6250- □ CB34 |
| 3 – 12 | 3RA6120- □ DB34 | 3RA6250- □ DB34 |
| 8 – 32 | 3RA6120- □ EB34 | 3RA6250- □ EB34 |



| AS-Interface accessories | |
|---|--------------|
| AS-i addressing unit | 3RK1904-2AB0 |
| AS-Interface mounting module for 3RA6 compact starter (24 V DC) | |
| Without additional inputs/outputs | 3RA6970-3A |
| With two local inputs | 3RA6970-3B |
| With two free external inputs | 3RA6970-3C |
| With one free external input and one free external output | 3RA6970-3D |
| With two free external outputs | 3RA6970-3E |
| For local control | 3RA6970-3F |



¹⁾ CPS: Control and protective switching device, IEC/EN 60947-6-2

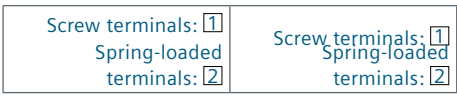

3RA68 infeed system (compact starter)

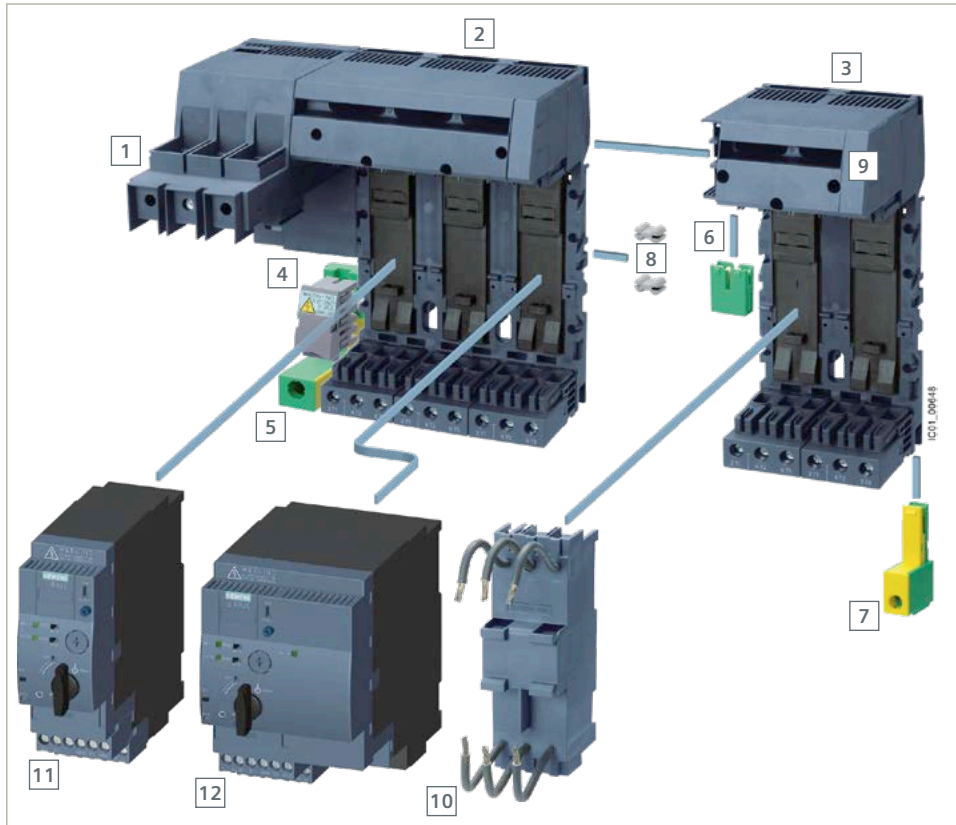

Item 4, 8 and 9 already included in the scope of delivery

| Type | Version of terminals | Article No. |
|--|-------------------------------------|-------------|
| 1 For busbar mounting (diagram) | | |
| Infeed with screw terminals 25/35 mm ² left with permanently fitted 3-socket expansion module | Screw terminals up to 63 A | 3RA6812-8AB |
| Infeed with screw terminals 25/35 mm ² left with permanently fitted 3-socket expansion module | Spring-loaded terminals up to 63 A | 3RA6812-8AC |
| Infeed with screw terminals 50 – 70 mm ² left with permanently fitted 3-socket expansion module | Screw terminals up to 100 A | 3RA6813-8AB |
| Infeed with screw terminals 50 – 70 mm ² left with permanently fitted 3-socket expansion module | Spring-loaded terminals up to 100 A | 3RA6813-8AC |
| Terminal covers for infeed w. screw terminals | 25/35 mm ² | 3RA6880-2AB |
| Terminal covers for infeed w. screw terminals | 50/70 mm ² | 3RA6880-3AB |
| Infeed with spring-loaded terminals 25/35 mm ² left or right up to 63 A | | 3RA6830-5AC |
| Expansion modules | | |
| 2 3-socket expansion module with 3 slots | Screw terminals | 3RA6823-0AB |
| 3 2-socket expansion module with 2 slots | Screw terminals | 3RA6822-0AB |
| 2-socket expansion module with 2 slots | Spring-loaded terminals | 3RA6822-0AC |
| 3-socket expansion module with 3 slots | Spring-loaded terminals | 3RA6823-0AC |
| 4 Expansion plug between 2 expansion modules (already included in the scope of delivery of the expansion modules) | | |
| 5 PE infeed | | |
| PE infeed 25/35 mm ² | Screw terminals | 3RA6860-6AB |
| PE infeed 25/35 mm ² | Spring-loaded terminals | 3RA6860-5AC |
| 6 PE expansion plug | | |
| 7 PE tap | | |
| PE tap 6/10 mm ² | Screw terminals | 3RA6870-4AB |
| PE tap 6/10 mm ² | Spring-loaded terminals | 3RA6870-3AC |
| 8 Connecting wedge (already included in scope of [2] and [3]) | | |
| 9 Cover cap of the power bus (already included in scope of [1]) | | |
| Further accessories | | |
| 10 Adapter 45 mm for 3RV motor starter protector with screw terminals | | 3RA6890-0BA |
| Expansion plug for SIRIUS 3RV29 infeed system | | 3RA6890-1AA |
| Terminal block for integration of 1-, 2- or 3-pole components | Spring-loaded terminals | 3RV2917-5D |
| 11 3RA61 compact direct-on-line starter | | |
| 12 3RA62 compact reversing starter | | |

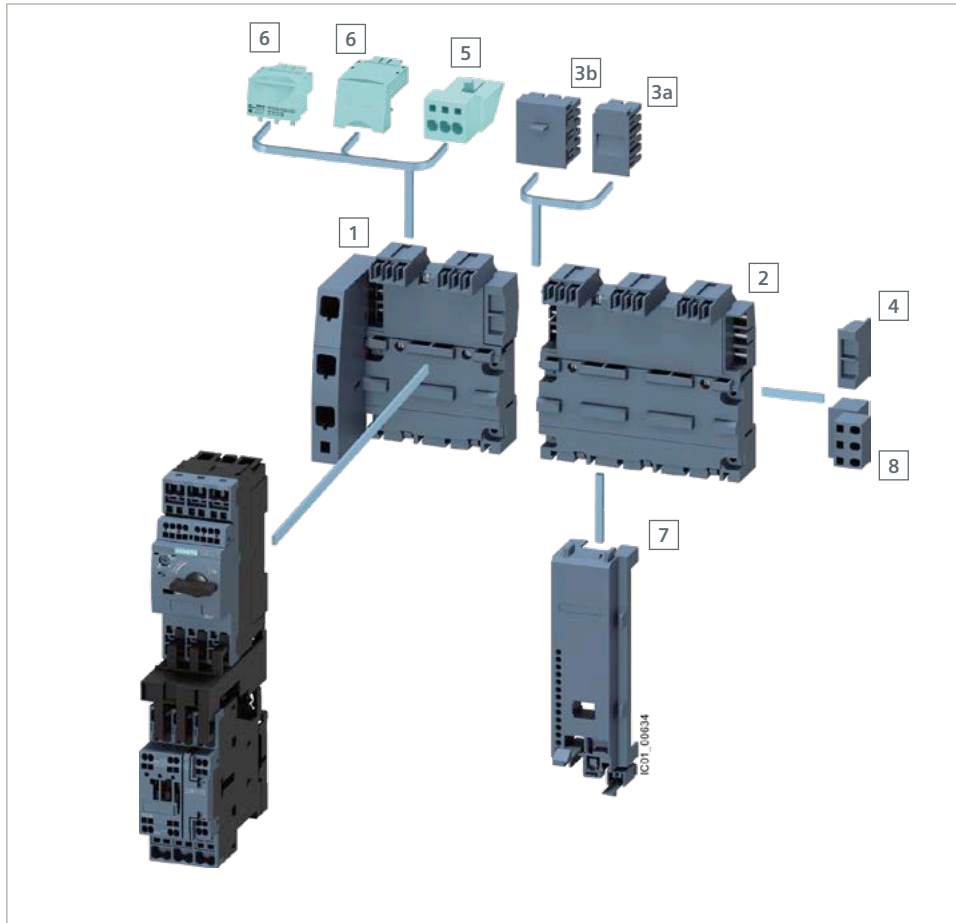

| Type | Version | Size for 3RV20, 3RV23 motor starter protectors | Article No. | | |
|---------------------------|---|--|---------------|---------------|---------------|
| 3-phase busbars | | | | | |
| 1 | With infeed on the left incl. 3RV2917-6A end cover | For 2 motor starter protectors | S00, S0 | 3RV2917-1A | |
| | With infeed on the right incl. 3RV2917-6A end cover | For 2 motor starter protectors | S00, S0 | 3RV2917-1E | |
| | For system expansion incl. 3RV2917-5BA00 expansion plug | For 2 motor starter protectors | S00, S0 | 3RV2917-4A | |
| 2 | For system expansion incl. 3RV2917-5BA00 expansion plug | For 3 motor starter protectors | S00, S0 | 3RV2917-4B | |
| Spare parts | | | | | |
| 3a | Expansion plug | | | 3RV2917-5BA00 | |
| 3b | Broadened expansion plug | | | 3RV2917-5E | |
| 4 | End cover | | | 3RV2917-6A | |
| Plug-in connectors | | | | | |
| 5 | Terminal block for device infeed | Spring-loaded terminals | 1 unit | S00/S0 | 3RV2917-5FA00 |
| 6 | For contacting the motor starter protectors | Screw terminals | 1 unit | S00 | 3RV2917-5CA00 |
| | | | 10 un. | S00 | 3RV2917-5C |
| | | Spring-loaded terminals | 1 unit | S00 | 3RV2917-5AA00 |
| | | | 10 un. | S00 | 3RV2917-5A |
| | | Screw terminals | 1 unit | S0 | 3RV1927-5AA00 |
| | | | 10 un. | S0 | 3RV1927-5A |
| Spring-loaded terminals | 1 unit | S0 | 3RV2927-5AA00 | | |
| | 10 un. | S0 | 3RV2927-5A | | |
| Accessories | | | | | |
| 7 | Contactor base for assembling direct-on-line or reversing starters or preassembled 3RA2 load feeders | | 1 unit | S00 | 3RV2917-7AA00 |
| | | | 1 unit | S00/S0 | 3RV2927-7AA00 |
| 8 | Terminal block for integration of 1-, 2- or 3-pole components | | | | 3RV2917-5D |
| | Mounting rail, 45 mm, for integrating other devices into the system, such as 5SY miniature circuit breakers | | | | 3RV1917-7B |

3-phase busbars /8US busbar adapters for infeed

| Type | Size | Article No. | | | |
|---|---------|-----------------------|-----------------------|-----------------------|-----------------------|
| 3-phase busbars | | | | | |
| For infeed to several 3RV2 motor starter protectors (screw terminals) mounted side-by-side on standard rails, with touch protection | | Modular spacing 45 mm | Modular spacing 55 mm | Modular spacing 63 mm | Modular spacing 75 mm |
| For 2 motor starter protectors | S00, S0 | 3RV1915-1AB | 3RV1915-2AB | 3RV1915-3AB | – |
| | S2 | – | 3RV1935-1A | – | 3RV1935-3A |
| 1 For 3 motor starter protectors | S00, S0 | 3RV1915-1BB | 3RV1915-2BB | – | – |
| | S2 | – | 3RV1935-1B | – | 3RV1935-3B |
| For 4 motor starter protectors | S00, S0 | 3RV1915-1CB | 3RV1915-2CB | 3RV1915-3CB | – |
| | S2 | – | 3RV1935-1C | – | 3RV1935-3C |
| For 5 motor starter protectors | S00, S0 | 3RV1915-1DB | 3RV1915-2DB | – | – |
| 3-phase infeed terminals | | | | | |
| 2 Connection from above | S00, S0 | 3RV2925-5AB | | | |
| | S2 | 3RV2935-5A | | | |
| Connection from below | S00, S0 | 3RV2915-5B | | | |
| 3-phase infeed terminals for constructing type E starters | | | | | |
| Connection from above | S00, S0 | 3RV2925-5EB | | | |
| | S2 | 3RV2935-5E | | | |
| Accessories | | | | | |
| Cover caps for connection tags Touch protection for empty positions | S00, S0 | 3RV1915-6AB | | | |
| | S2 | 3RV1935-6A | | | |

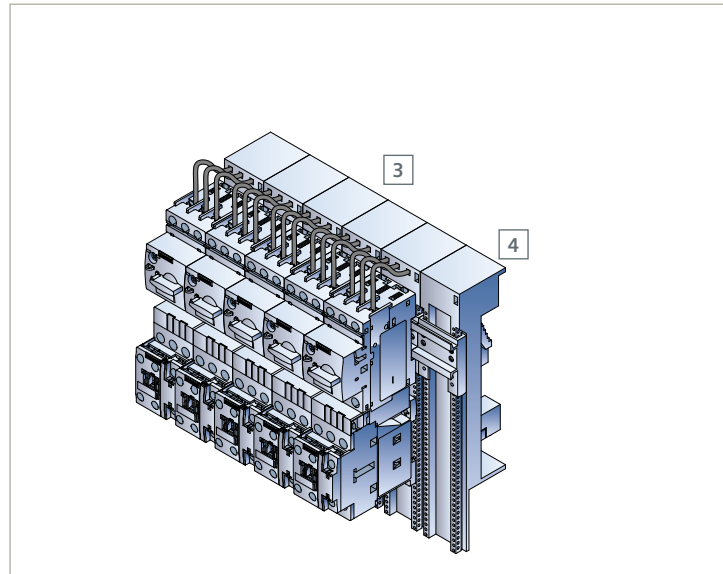
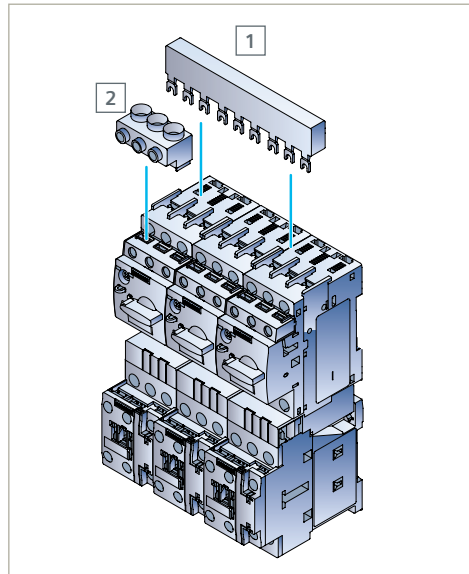

| For MSPs, size | Rated operational current [A] | Adapter length [mm] | Adapter width [mm] | Article No. |
|---|-------------------------------|---------------------|--------------------|-----------------------------|
| 3 Busbar adapters for 60-mm systems | | | | |
| For 3RM1 motor starters with fuse module 3RM193 □-□□□□ | | | | |
| 22.5 mm | 7 | 200 | 22.5 | 8US1216-0AS00 ²⁾ |
| For motor starter protectors and load feeders with screw type terminals | | | | |
| S00, S0 | 25 | 200 | 45 | 8US1251-5DS10 |
| S0 | 32 | 200 | 45 | 8US1251-5NS10 |
| S2 | 80 | 200 | 55 | 8US1261-5MS13 |
| S2 | 80 | 260 | 55 | 8US1261-6MT10 |
| S2 ¹⁾ | 80 | 260 | 118 | 8US1211-6MT10 |
| S3 | 100 | 215 | 72 | 8US1211-4TR00 |
| For motor starter protectors and load feeders with spring-loaded terminals | | | | |
| S00, S0 | 25 | 200 | 45 | 8US1251-5DS11 |
| S00, S0 | 25 | 260 | 45 | 8US1251-5DT11 |
| S0 | 32 | 260 | 45 | 8US1251-5NT11 |

¹⁾ For the assembly of feeders for reversing starters comprising a motor starter protector and two contactors

²⁾ Adapter for 8US1616-0AK02 compact busbar system

| Accessories | | | | |
|--|--------|----|--|---------------|
| 4 Device holder for lateral mounting on busbar adapters | 200 | 45 | | 8US1250-5AS10 |
| | 260 | 45 | | 8US1250-5AT10 |
| Side module for widening busbar adapters | 200 | 9 | | 8US1998-2BJ10 |
| Spacer for fixing the feeder onto the busbar adapter | | | | 8US1998-1BA10 |
| Vibration and shock kit for increased vibration and shock loads | S00/S0 | | | 8US1998-1CA10 |
| | S2 | | | 8US1998-1DA10 |

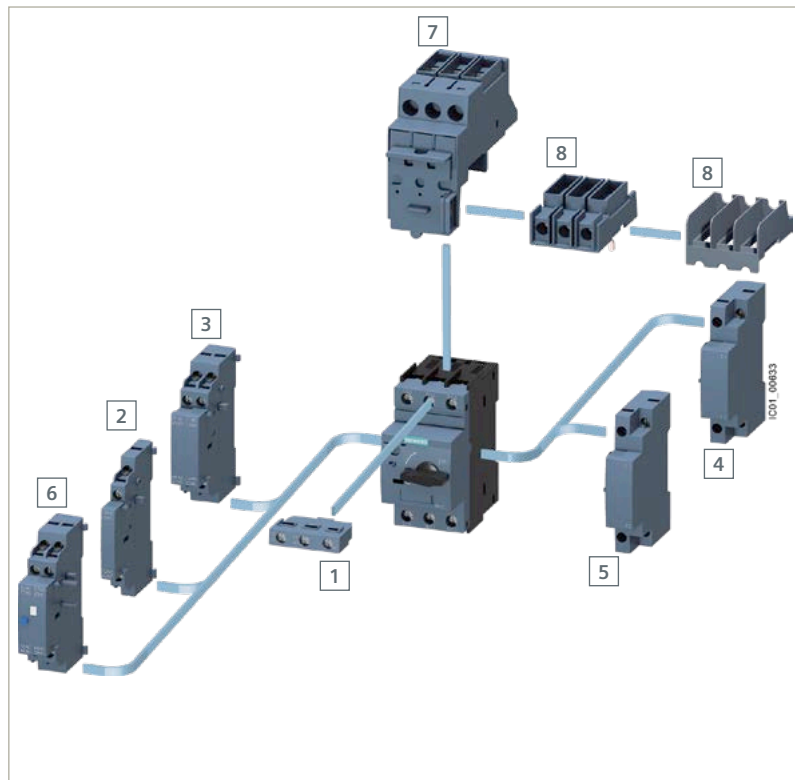

| Type | Version | Article No. screw terminals | Article No. spring-loaded terminals |
|---|-----------------|-----------------------------|-------------------------------------|
| Accessories for 3RV motor starter protectors sizes S00, S0, S2 | | | |
| Auxiliary and signaling switches | | | |
| 1 Transverse auxiliary switch | 1CO | 3RV2901-1D | – |
| | 1NO + 1NC | 3RV2901-1E | 3RV2901-2E |
| | 2NO | 3RV2901-1F | 3RV2901-2F |
| 1 Solid-state-compatible auxiliary switch | 1CO | 3RV2901-1G | – |
| | 1NO + 1NC | 3RV2901-1A | 3RV2901-2A |
| | 2NO | 3RV2901-1B | 3RV2901-2B |
| 2 Lateral auxiliary switch with 2 contacts | 2NC | 3RV2901-1C | 3RV2901-2C |
| | 2NO + 2NC | 3RV2901-1J | – |
| 3 Lateral auxiliary switch with 4 contacts | | | |
| 6 Signaling switch | | 3RV2921-1M | 3RV2921-2M |
| Auxiliary releases | | | |
| 4 Shunt release ¹⁾ | 20 – 70 V AC/DC | 3RV2902-1DB0 | 3RV2902-2DB0 |
| | 210 – 240 V AC | 3RV2902-1DPO | 3RV2902-2DPO |
| 5 Undervoltage release ¹⁾ | 230 V AC | 3RV2902-1AP0 | 3RV2902-2AP0 |
| | 400 V AC | 3RV2902-1AV0 | 3RV2902-2AV0 |
| 5 Undervoltage release with leading auxiliary contacts | 230 V AC | 3RV2922-1CP0 | 3RV2922-2CP0 |
| | 400 V AC | 3RV2922-1CV0 | 3RV2922-2CV0 |
| | 415 V AC | 3RV2922-1CV1 | 3RV2922-2CV1 |
| Isolator module and terminal blocks | | | |
| 7 Isolator module | S00, S0 | 3RV2928-1A | – |
| | S2 | 3RV2938-1A | – |
| 8 Terminal block type E for increased clearances and creepage distances | S00, S0 | 3RV2928-1H | – |
| 8 Terminal block type E for S3 | S3 | 3RT2946-4GA07 | – |
| 8 Phase barriers f. incr. clearances/creepage distances | S00, S0 | 3RV2928-1K | – |
| | S2 | 3RV2938-1K | – |

| Type | Version | Article No. |
|--|---------|---------------|
| Door-coupling rotary operating mechanisms | | |
| Door-coupling rotary operating mech. (black) with extension shaft ²⁾ | 130 mm | 3RV2926-0B |
| Door-coupling rotary operating mech. (black) with extension shaft | 330 mm | 3RV2926-0K |
| EMERGENCY-STOP door-cpl. rot. oper. mech. (red/yellow) w. ext. shaft ²⁾ | 130 mm | 3RV2926-0C |
| EMERGENCY-STOP door-cpl. rot. oper. mech. (red/yellow) w. ext. shaft | 330 mm | 3RV2926-0L |
| Molded-plastic enclosures for surface mounting | | |
| For motor starter protector (+ lateral auxiliary switch) S00, S0 | 54 mm | 3RV1923-1CA00 |
| For motor starter protector (+ lateral aux. switch + auxiliary release) S00, S0 | 72 mm | 3RV1923-1DA00 |
| For motor starter protector (+ lateral auxiliary switch + auxiliary release) S2 | 82 mm | 3RV1933-1DA00 |
| Molded-plastic enclosure for surface mounting with EMERGENCY-STOP door-cpl. rot. op. mech. f. MSP (+ lateral aux. switch) S00, S0 | 54 mm | 3RV1923-1FA00 |
| Molded-plastic enclosure for surface mounting w. EMERGENCY-STOP door-cpl. rot. op. mech. f. MSP (+ lateral aux. switch + aux. release) S00, S0 | 72 mm | 3RV1923-1GA00 |
| Molded-plastic enclosure for surface mounting w. EMERGENCY-STOP door-cpl. rot. oper. mech. f. MSP (+ lateral aux. switch + aux. release) S2 | 82 mm | 3RV1933-1GA00 |

¹⁾ Other versions on request ²⁾ The operating mechanism is also suitable for 3RA6 compact starters

Accessories for 3RT201 contactors (S00)

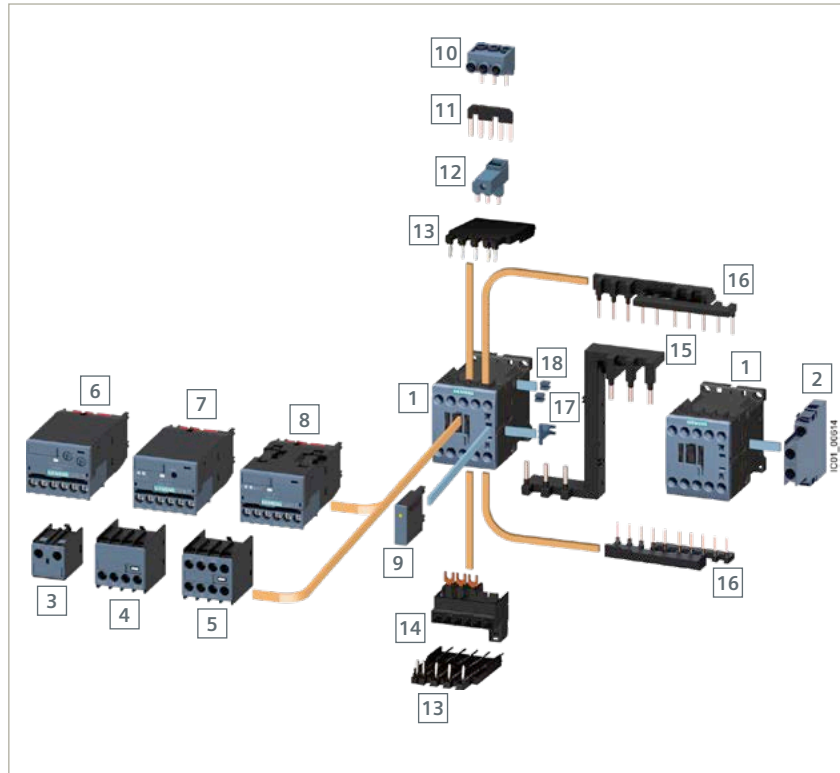

| Fitting of auxiliary switches on the front for | | Version | Article No. screw terminals | Article No. spring-loaded terminals | | |
|--|--|-------------------------------|-------------------------------------|-------------------------------------|---------------|---------------|
| 1 | 3RT2 contactors | Standard | | | | |
| | Laterally mountable auxiliary switch blocks | 2NO | 3RH2911-1DA20 | 3RH2911-2DA20 | | |
| | | 1NO + 1NC | 3RH2911-1DA11 | 3RH2911-2DA11 | | |
| | | 2NC | 3RH2911-1DA02 | 3RH2911-2DA02 | | |
| 2 | Solid-state-compatible auxiliary switch block laterally mountable, right | 1NO + 1NC | – | 3RH2911-2DE11 | | |
| | Solder pin adapter for contactors with 4-pole auxiliary switch block | For 4 contactors (package) | 3RT1916-4KA2 | – | | |
| 3 | 1-pole auxiliary switch block, cable entry from above | 1NO | 3RH2911-1AA10 | – | | |
| | | 1NC | 3RH2911-1AA01 | – | | |
| | 1-pole auxiliary switch block, cable entry from below | 1NO | 3RH2911-1BA10 | – | | |
| | | 1NC | 3RH2911-1BA01 | – | | |
| 4 | 2-pole auxiliary switch block, cable entry from above | 1NO + 1NC | 3RH2911-1LA11 | – | | |
| | | 2NO | 3RH2911-1LA20 | – | | |
| | | 1NO + 1NC | 3RH2911-1MA11 | – | | |
| | 2-pole auxiliary switch block, cable entry from below | 2NO | 3RH2911-1MA20 | – | | |
| | | 5 | 1- to 4-pole auxiliary switch block | 1NC | 3RH2911-1HA01 | 3RH2911-2HA01 |
| | | | | 2NC | 3RH2911-1HA02 | 3RH2911-2HA02 |
| 1NO + 1NC | 3RH2911-1HA11 | | | 3RH2911-2HA11 | | |
| 2NO + 2NC | 3RH2911-1HA22 | | | 3RH2911-2HA22 | | |
| | Solid-state-compatible auxiliary switch blocks 2-pole | 1NO | 3RH2911-1HA10 | 3RH2911-2HA10 | | |
| | | 2NO | 3RH2911-1HA20 | 3RH2911-2HA20 | | |
| | | 1NO + 1NC | 3RH2911-1NF11 | 3RH2911-2NF11 | | |
| | | 2NO | 3RH2911-1NF20 | 3RH2911-2NF20 | | |
| | | 2NC | 3RH2911-1NF02 | 3RH2911-2NF02 | | |
| [6] [7] [8] Function modules for mounting on contactors and for connecting to the automation level | | | | | | |
| | Surge suppressor, e.g. varistor | | | | | |
| 9 | Without LED | 127 – 240 V AC | 3RT2916-1BD00 | 3RT2916-1BD00 | | |
| | With LED | 127 – 240 V AC | 3RT2916-1JL00 | 3RT2916-1JL00 | | |
| 10 | 3-phase infeed terminal | Conductor cross section: 6 mm | 3RA2913-3K | – | | |
| 11 | Neutral bridge, 3-pole | – | 3RT1916-4BA31 | 3RT2916-4BA32 | | |
| 12 | Parallel connector, 3-pole | For main circuits | 3RT1916-4BB31 | – | | |
| 13 | Solder pin adapter for contactors | For 4 contactors (package) | 3RT1916-4KA1 | – | | |
| 14 | Terminal module for contactor with screw terminals | Adapter | 3RT1916-4RD01 | – | | |
| | | Plug | 3RT1900-4RE01 | – | | |
| 15 | Safety main circuit connector | – | 3RA2916-1A | – | | |
| 16–18 | Wiring kit | – | 3RA2913-2AA1 | 3RA2913-2AA2 | | |

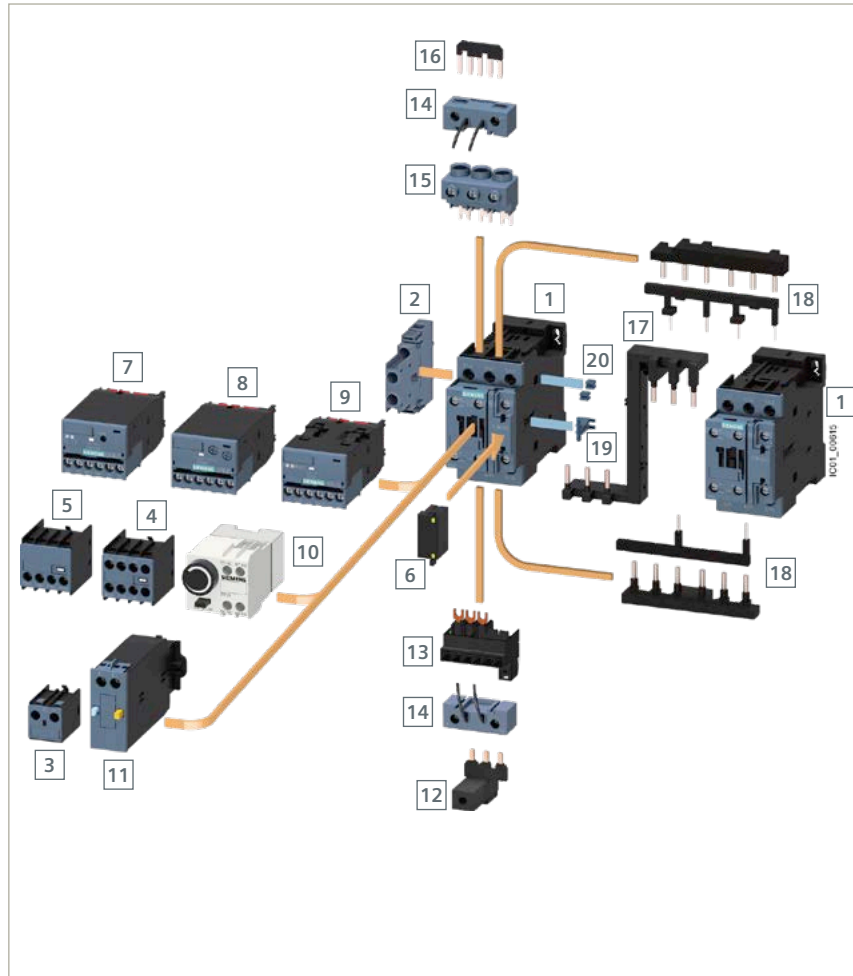

| Fitting of auxiliary switches on the front for | | Version | Article No. screw terminals | Article No. spring-loaded terminals | |
|--|--|---|--|-------------------------------------|---------------|
| 1 | 3RT2 contactors | Standard | | | |
| 2 | Laterally mountable auxiliary switch blocks | 2NO | 3RH2921-1DA20 | 3RH2921-2DA20 | |
| | | 1NO + 1NC | 3RH2921-1DA11 | 3RH2921-2DA11 | |
| | | 2NC | 3RH2921-1DA02 | 3RH2921-2DA02 | |
| | Solid-state-compatible auxiliary switch block, laterally mountable | 1NO + 1NC | – | 3RH2921-2DE11 | |
| 3 | 1-pole auxiliary switch block, cable entry from above | 1NO | 3RH2911-1AA10 | – | |
| | | 1NC | 3RH2911-1AA01 | – | |
| | | 1-pole auxiliary switch block, cable entry from below | 1NO | 3RH2911-1BA10 | – |
| | | 1NC | 3RH2911-1BA01 | – | |
| 4 | 1- to 4-pole auxiliary switch block | 1NC | 3RH2911-1HA01 | 3RH2911-2HA01 | |
| | | 2NC | 3RH2911-1HA02 | 3RH2911-2HA02 | |
| | | 1NO + 1NC | 3RH2911-1HA11 | 3RH2911-2HA11 | |
| | | 2NO + 2NC | 3RH2911-1HA22 | 3RH2911-2HA22 | |
| | | 1NO | 3RH2911-1HA10 | 3RH2911-2HA10 | |
| | | 2NO | 3RH2911-1HA20 | 3RH2911-2HA20 | |
| | | Solid-state-compatible auxiliary switch blocks 2-pole | 1NO + 1NC | 3RH2911-1NF11 | 3RH2911-2NF11 |
| | | | 2NO | 3RH2911-1NF20 | 3RH2911-2NF20 |
| | | | 2NC | 3RH2911-1NF02 | 3RH2911-2NF02 |
| 5 | 2-pole auxiliary switch block, cable entry from above | 1NO + 1NC | 3RH2911-1LA11 | – | |
| | | 2NO | 3RH2911-1LA20 | – | |
| | | 2-pole auxiliary switch block, cable entry from below | 1NO + 1NC | 3RH2911-1MA11 | |
| 2NO | 3RH2911-1MA20 | | | | |
| 6 | Surge suppressor, e.g. varistor | Without LED | | | |
| | | With LED | | | |
| | | 127 – 240 V AC | 3RT2926-1BD00 | 3RT2926-1BD00 | |
| | | 127 – 240 V AC | 3RT2926-1JL00 | 3RT2926-1JL00 | |
| 7 | 8 | 9 | Function modules for mounting on contactors and for connecting to the automation level | | |
| 10 | Pneumatic delay block 1NO + 1NC | ON-delay, 0.1 – 30 s | 3RT2926-2PA01 | – | |
| | | ON-delay, 1 – 60 s | 3RT2926-2PA11 | – | |
| | | OFF-delay, 0.1 – 30 s | 3RT2926-2PRO1 | – | |
| | | OFF-delay, 1 – 60 s | 3RT2926-2PR11 | – | |
| 11 | Mechanical latch | 230 V AC/DC | 3RT2926-3AP31 | 3RT2926-3AP31 | |
| 12 | Parallel connector, 3-pole | For main circuits | 3RT2926-4BB31 | – | |
| 13 | Terminal module for contactor with screw terminals | Adapter | 3RT1926-4RD01 | – | |
| | | Plug | 3RT1900-4RE01 | | |
| 14 | Coil terminal module | Connection from above | 3RT2926-4RA11 | 3RT2926-4RA12 | |
| | | Connection from below | 3RT2926-4RB11 | 3RT2926-4RB12 | |
| | | Connection diagonally | 3RT2926-4RC11 | 3RT2926-4RC12 | |
| 15 | 3-phase infeed terminal | – | 3RV2925-5AB | – | |
| 16 | Neutral bridge, 3-pole | – | 3RT1926-4BA31 | 3RT2926-4BA32 | |
| 17 | Safety main circuit connector | For series switching of 2 contactors | 3RA2926-1A | – | |
| 18–20 | Wiring kit | For reversing combinations | 3RA2923-2AA1 | 3RA2923-2AA2 | |

Accessories for 3RT203 contactors (S2)

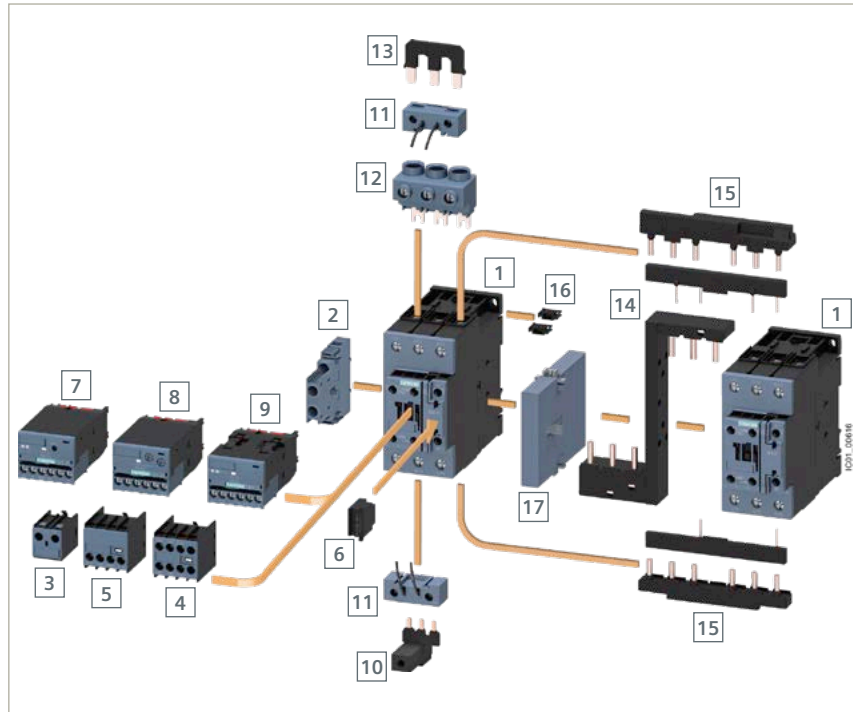

| Fitting of auxiliary switches on the front for | | Version | Article No. screw terminals | Article No. spring-loaded terminals |
|--|--|--------------------------------------|--|-------------------------------------|
| 1 | 3RT2 contactors | Standard | | |
| 2 | Laterally mountable auxiliary switch blocks | 2NO | 3RH2921-1DA20 | 3RH2921-2DA20 |
| | | 1NO + 1NC | 3RH2921-1DA11 | 3RH2921-2DA11 |
| | | 2NC | 3RH2921-1DA02 | 3RH2921-2DA02 |
| | Solid-state-compatible auxiliary switch block, laterally mountable | 1NO + 1NC | – | 3RH2921-2DE11 |
| 3 | 1-pole auxiliary switch block, cable entry from above | 1NO | 3RH2911-1AA10 | – |
| | | 1NC | 3RH2911-1AA01 | – |
| | 1-pole auxiliary switch block, cable entry from below | 1NO | 3RH2911-1BA10 | – |
| | | 1NC | 3RH2911-1BA01 | – |
| 4 | 1- to 4-pole auxiliary switch block | 1NC | 3RH2911-1HA01 | 3RH2911-2HA01 |
| | | 2NC | 3RH2911-1HA02 | 3RH2911-2HA02 |
| | | 1NO + 1NC | 3RH2911-1HA11 | 3RH2911-2HA11 |
| | | 2NO + 2NC | 3RH2911-1HA22 | 3RH2911-2HA22 |
| | | 1NO | 3RH2911-1HA10 | 3RH2911-2HA10 |
| | | 2NO | 3RH2911-1HA20 | 3RH2911-2HA20 |
| | Solid-state-compatible auxiliary switch 2-pole | 1NO + 1NC | 3RH2911-1NF11 | 3RH2911-2NF11 |
| | | 2NO | 3RH2911-1NF20 | 3RH2911-2NF20 |
| | | 2NC | 3RH2911-1NF02 | 3RH2911-2NF02 |
| 5 | 2-pole auxiliary switch block, cable entry from above | 1NO + 1NC | 3RH2911-1LA11 | – |
| | | 2NO | 3RH2911-1LA20 | – |
| | 2-pole auxiliary switch block, cable entry from below | 1NO + 1NC | 3RH2911-1MA11 | |
| | | 2NO | 3RH2911-1MA20 | |
| 6 | Surge suppressor, e.g. varistor (230 V AC) | Without LED | | |
| | | 127 – 240 V AC | 3RT2936-1BD00 | 3RT2936-1BD00 |
| | | With LED | 127 – 240 V AC | 3RT2936-1JL00 |
| 7 | 8 | 9 | Function modules for mounting on contactors and for connecting to the automation level | |
| 10 | Parallel connector, 3-pole | For main circuits | 3RT1936-4BB31 | – |
| 11 | Coil terminal module | Connection from above | 3RT2926-4RA11 | – |
| | | Connection from below | 3RT2926-4RB11 | – |
| | | Connection diagonally | 3RT2926-4RC11 | – |
| 12 | 3-phase infeed terminal | – | 3RV2935-5A | – |
| 13 | Neutral bridge, 3-pole | – | 3RT1936-4BA31 | – |
| 14 | Safety main circuit connector | For series switching of 2 contactors | 3RA2936-1A | – |
| 15 | Wiring kit | For reversing combinations | 3RA2933-2AA1 | – |
| 16 | Mechanical interlock | – | 3RA2934-2B | 3RA2934-2B |

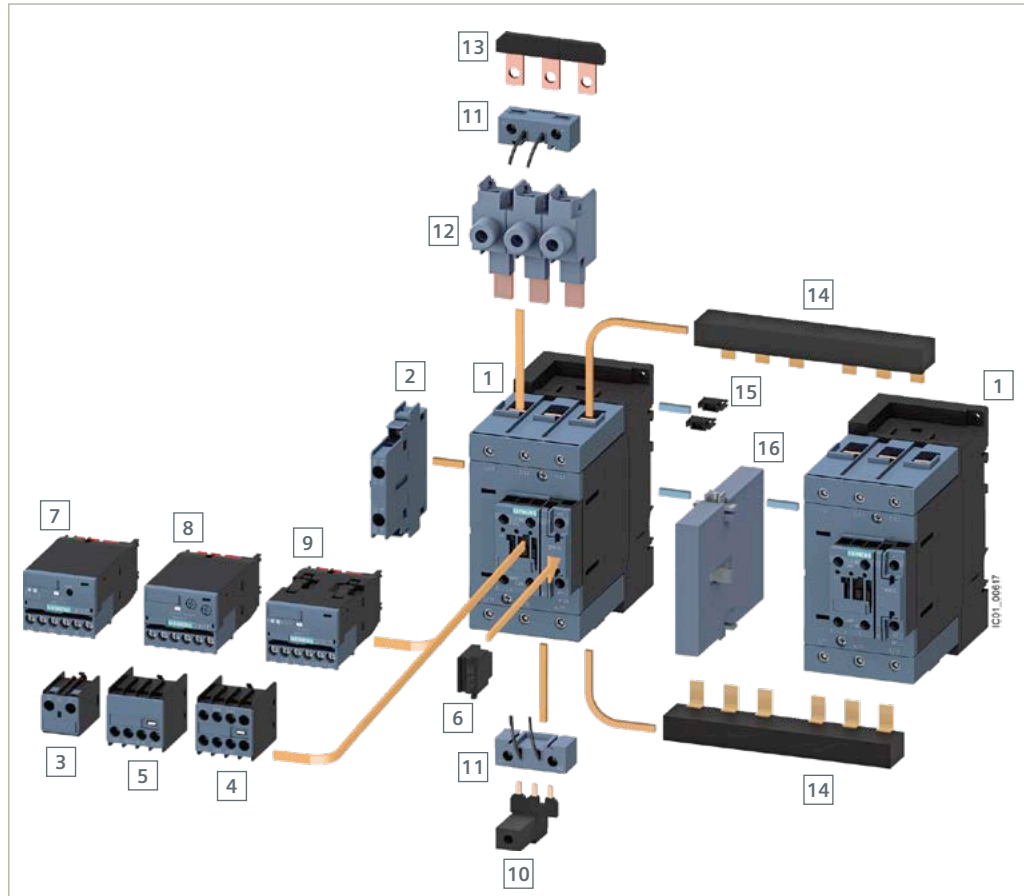

| Fitting of auxiliary switches on the front for | Version | Article No. screw terminals | Article No. spring-loaded terminals |
|---|----------------------------|-----------------------------|-------------------------------------|
| 1 3RT2 contactors | Standard | | |
| 2 Laterally mountable auxiliary switch blocks | 2NO | 3RH2921-1DA20 | 3RH2921-2DA20 |
| | 1NO + 1NC | 3RH2921-1DA11 | 3RH2921-2DA11 |
| | 2NC | 3RH2921-1DA02 | 3RH2921-2DA02 |
| Solid-state-compatible auxiliary switch block, laterally mountable | 1NO + 1NC | – | 3RH2921-2DE11 |
| 3 1-pole auxiliary switch block, cable entry from above | 1NO | 3RH2911-1AA10 | – |
| | 1NC | 3RH2911-1AA01 | – |
| 1-pole auxiliary switch block, cable entry from below | 1NO | 3RH2911-1BA10 | – |
| | 1NC | 3RH2911-1BA01 | – |
| 4 1- to 4-pole auxiliary switch block | 1NC | 3RH2911-1HA01 | 3RH2911-2HA01 |
| | 2NC | 3RH2911-1HA02 | 3RH2911-2HA02 |
| | 1NO + 1NC | 3RH2911-1HA11 | 3RH2911-2HA11 |
| | 2NO + 2NC | 3RH2911-1HA22 | 3RH2911-2HA22 |
| | 1NO | 3RH2911-1HA10 | 3RH2911-2HA10 |
| | 2NO | 3RH2911-1HA20 | 3RH2911-2HA20 |
| Solid-state-compatible auxiliary switch blocks, 2-pole | 1NO + 1NC | 3RH2911-1NF11 | 3RH2911-2NF11 |
| | 2NO | 3RH2911-1NF20 | 3RH2911-2NF20 |
| | 2NC | 3RH2911-1NF02 | 3RH2911-2NF02 |
| 5 2-pole auxiliary switch block, cable entry from above | 1NO + 1NC | 3RH2911-1LA11 | – |
| | 2NO | 3RH2911-1LA20 | – |
| | 1NO + 1NC | 3RH2911-1MA11 | – |
| 2-pole auxiliary switch block, cable entry from above | 2NO | 3RH2911-1MA20 | – |
| | | | |
| 6 Surge suppressor, e.g. varistor (230 V AC) | Without LED | 127 – 240 V AC | 3RT2936-1BD00 |
| | With LED | 127 – 240 V AC | 3RT2936-1JL00 |
| 7 8 9 Function modules for mounting on contactors and for connecting to the automation level | | | |
| 10 Parallel connector, 3-pole | For main circuits | 3RT1946-4BB31 | – |
| 11 Coil terminal module | Connection from above | 3RT2926-4RA11 | – |
| | Connection from below | 3RT2926-4RB11 | – |
| | Connection diagonally | 3RT2926-4RC11 | – |
| 12 1-phase infeed terminal (3 units) | | 3RA2943-3L | – |
| 13 Neutral bridge, 3-pole | | 3RT1946-4BA31 | – |
| 14 Wiring modules | For reversing combinations | 3RA2943-2AA1 | – |
| 15 Mechanical interlock | | 3RA2934-2B | 3RA2934-2B |

Accessories for 3RT1 contactors (S6 – S12)

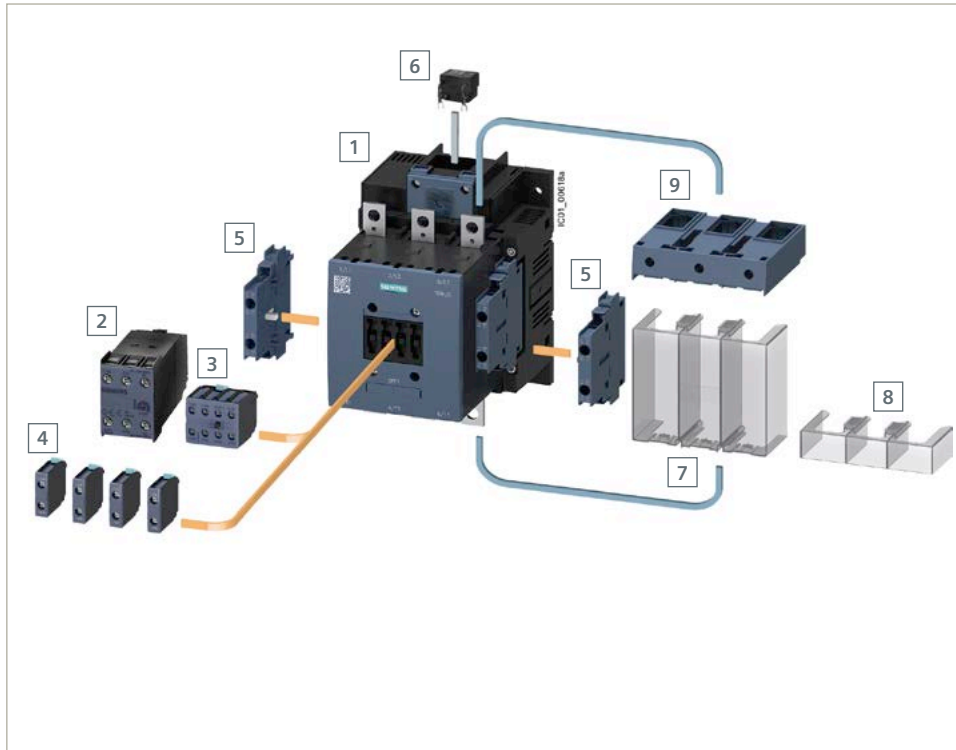

| Type | Version | Article No. | |
|--|---|--------------------|------------|
| 1 3RT1 contactors | Standard | | |
| 2 2-pole auxiliary switch block, lateral – ON-delay, 200 – 240 V AC – OFF-delay, 200 – 240 V AC | 1NO + 1NC | | |
| | 0.5 ... 10 s | 3RT1926-2ED21 | |
| | 0.5 ... 10 s | 3RT1926-2FL21 | |
| 3 4-pole auxiliary switch block (on front, screw terminals) | 2NO + 2NC | 3RH1921-1XA22-0MA0 | |
| 4 1-pole auxiliary switch block (on front, screw terminals) | 1NC | 3RH1921-1CA01 | |
| | 1NO | 3RH1921-1CA10 | |
| 5 2-pole auxiliary switch block (on side, screw terminals) acc. to EN 50012 acc. to EN 50005 | 1NO + 1NC | 3RH1921-1JA11 | |
| | 1NO + 1NC | 3RH1921-1KA11 | |
| | 2NC | 3RH1921-1KA02 | |
| | 2NO | 3RH1921-1KA20 | |
| 6 Surge suppressor (RC element), 127 ... 240 V AC (screw terminals) | For S6 – S12 | 3RT1956-1CD00 | |
| 7 Terminal cover for cable lug and busbar connections | For S6 | 3RT1956-4EA1 | |
| | For S10/S12 | 3RT1966-4EA1 | |
| 8 Terminal cover for box terminals | For S6 | 3RT1956-4EA2 | |
| | For S10/S12 | 3RT1966-4EA2 | |
| Terminal cover for box terminals | | | |
| 9 | For round and ribbon cable conductors up to 70 mm ² | S6 | 3RT1955-4G |
| | For round and ribbon cable conductors up to 120 mm ² | S6 | 3RT1956-4G |
| | For round and ribbon cable conductors up to 240 mm ² | S10/S12 | 3RT1966-4G |

Operating mechanism types

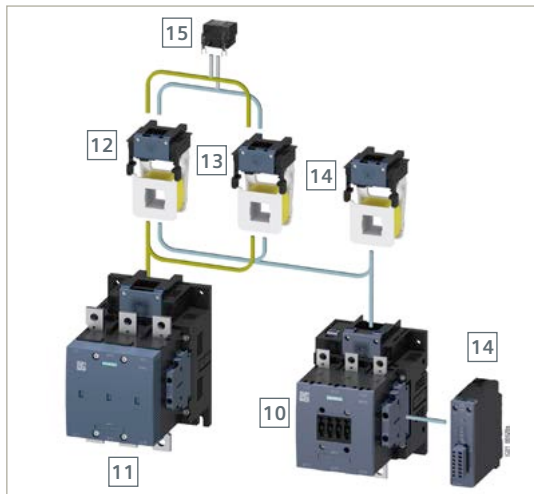

| | |
|----|--|
| 10 | 3RT10 and 3RT14 air-break contactor, sizes S6, S10 and S12 |
| 11 | 3RT12 vacuum contactor, sizes S10 and S12 |
| 12 | Withdrawable coils for contactors with 3RT1...-A.. conventional op. mech. |
| 13 | Withdrawable coils for contactors with 3RT1...-N.. electronic op. mech. |
| 14 | Withdrawable coils and lateral mounting module (snap-on) for 3RT1...-P.. contactors w. el. oper. mech. and remaining lifetime signal |
| 15 | RC element, 127 – 240 V AC |

| Size | Three-phase motor 400 V kW | Contactor without coil Article No. | Withdrawable coil for op. mech. | |
|------|--------------------------------------|--|---------------------------------|---------------|
| | | | Conventional | Electronic |
| | | | Control supply voltage | |
| S6 | 55 | 3RT1054-1LA06 | 3RT1955-5AP31 | 3RT1955-5NP31 |
| | 75 | 3RT1055-6LA06 | | |
| | 90 | 3RT1056-6LA06 | | |
| S10 | 110 | 3RT1064-6LA06 | 3RT1965-5AP31 | 3RT1965-5NP31 |
| | 132 | 3RT1065-6LA06 | | |
| | 160 | 3RT1066-6LA06 | | |
| S12 | 200 | 3RT1075-6LA06 | 3RT1975-5AP31 | 3RT1975-5NP31 |
| | 250 | 3RT1076-6LA06 | | |
| | | 11 | 12 | 13 |

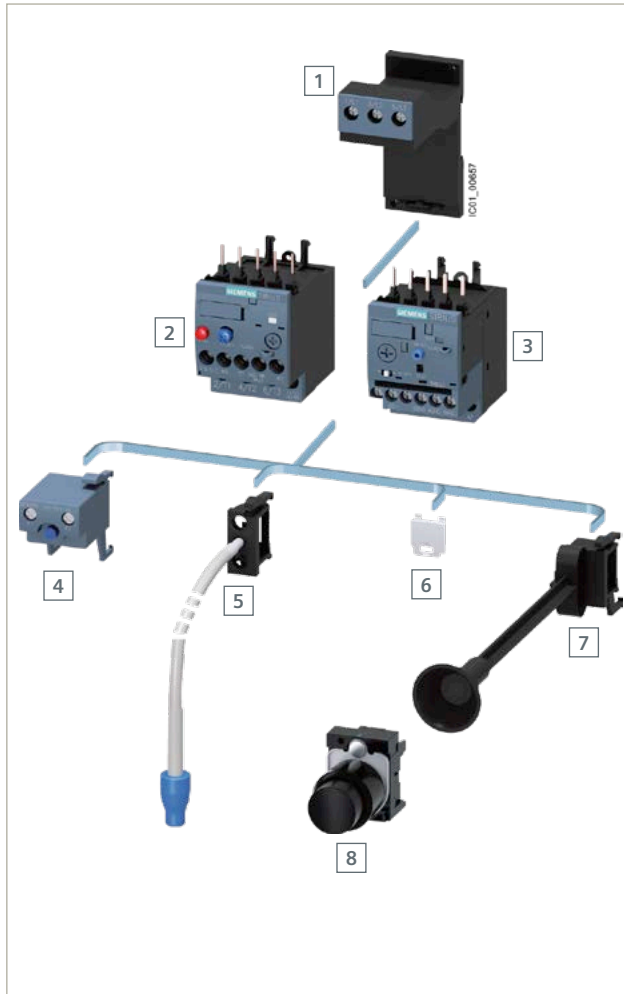

| Version | For size | Article No. |
|--|--|-----------------------------|
| Terminal supports for stand-alone installation | | |
| 1 | Screw fastening and snap-on mounting onto TH 35 standard mounting rail | S00 3RU2916-3A □ 01 |
| | Screw fastening and snap-on mounting onto TH 35 standard mounting rail | S0 3RU2926-3A □ 01 |
| | Screw fastening and snap-on mounting onto TH 35 standard mounting rail | S2 3RU2936-3AA01 |
| | Screw fastening and snap-on mounting onto TH 35 standard mounting rail | S3 3RU2946-3AA01 |
| Mechanical RESET comprising: | | |
| 4 | 24 – 30 V AC/DC | S00 – S3 3RU1900-2AB71 |
| | 110 – 127 V AC/DC | S00 – S3 3RU1900-2AF71 |
| | 220 – 250 V AC/DC | S00 – S3 3RU1900-2AM71 |
| Cable releases with holders for RESET for drill holes Ø 6.5 mm in the control panel | | |
| 5 | Length 400 mm | S00 – S3 3RU2900-1B |
| | Length 400 mm | S00 – S3 3RB3980-0B |
| | Length 600 mm | S00 – S3 3RU2900-1C |
| | Length 600 mm | S00 – S3 3RB3980-0C |
| Sealable cover for 3RB3, 3RU2, 3RR2, transparent | | |
| 6 | For covering the setting knobs | S00 – S3 3RV2908-0P |
| | For covering the setting knobs | S00 – S3 3RB3984-0 |
| | For covering the setting knobs | S00 – S3 3RR2940 |
| Modules for electrical remote reset | | |
| 7 | Resetting plungers, holders and formers | S00 – S3 3RU2900-1A |
| | Resetting plungers, holders and formers | S00 – S3 3RB3980-0A |
| 8 | Push buttons with extended stroke (12 mm), IP65, Ø 22 mm | S00 – S3 3SU1200-0FB10-0AA0 |
| | Extension plungers for compensation of the distance between a push button and the unlatching button of the relay | S00 – S3 3SU1900-0KG10-0AA0 |



| Can be combined with the following overload and current monitoring relays | | | | |
|---|------|---|------|------|
| 2 | 3RU2 | 3 | 3RB3 | 3RR2 |
| | ■ | | ■ | ■ |
| | ■ | | ■ | ■ |
| | ■ | | ■ | ■ |
| | ■ | | ■ | ■ |
| | ■ | | | |
| | ■ | | | |
| | ■ | | ■ | |
| | ■ | | ■ | |
| | ■ | | | ■ |
| | ■ | | ■ | |
| | ■ | | ■ | |
| | ■ | | ■ | |

Screw terminals: A
Spring-loaded terminals: C

Accessories for 3RB20/21 electronic overload relays (S6 – S12)

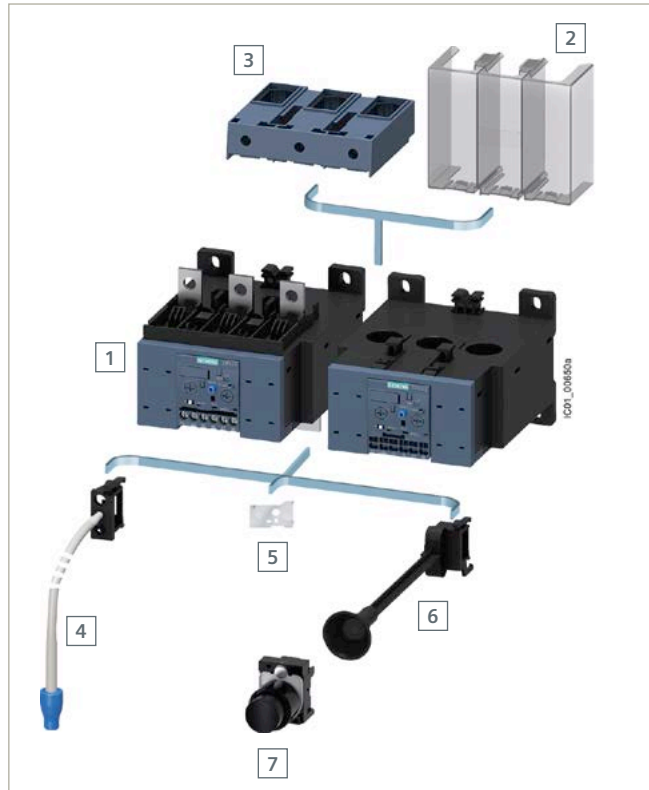

| Version | For size | Article No. |
|---|----------|--------------------|
| 1 3RB20/21 electronic overload relays | | |
| Terminal covers for 3RB20/21 | | |
| Cover for cable terminal lugs and busbar connections | S6 | 3RT1956-4EA1 |
| | S10/S12 | 3RT1966-4EA1 |
| Cover for box terminals | S6 | 3RT1956-4EA2 |
| | S10/S12 | 3RT1966-4EA2 |
| | S6 | 3RT1956-4EA3 |
| Cover for screw terminals between contactor and overload relay without box terminal (1 unit required per combination) | S10/S12 | 3RT1966-4EA3 |
| Box terminal block | | |
| For round and ribbon cable conductors up to 70 mm ² | S6 | 3RT1955-4G |
| For round and ribbon cable conductors up to 120 mm ² | S6 | 3RT1956-4G |
| For round and ribbon cable conductors up to 240 mm ² | S10/S12 | 3RT1966-4G |
| Cable releases with holders for RESET and 3RB20/21 for holes Ø 6.5 mm in the control panel, max. control panel thickness 8 mm | | |
| Length 400 mm | S6 – S12 | 3RB3980-0B |
| Length 600 mm | | 3RB3980-0C |
| 5 Sealable cover for 3RB20/21, transparent | | |
| For covering the setting knobs | S6 – S12 | 3RB3984-0 |
| Mechanical RESET and 3RB20/21 comprising: | | |
| Resetting plungers, holders and formers | S6 – S12 | 3RB3980-0A |
| Push buttons with extended stroke (12 mm), IP65, Ø 22 mm | S6 – S12 | 3SU1200-0FB10-0AA0 |
| Extension plungers for compensation of the distance between a push button and the unlatching button of the relay | S6 – S12 | 3SU1900-0KG10-0AA0 |

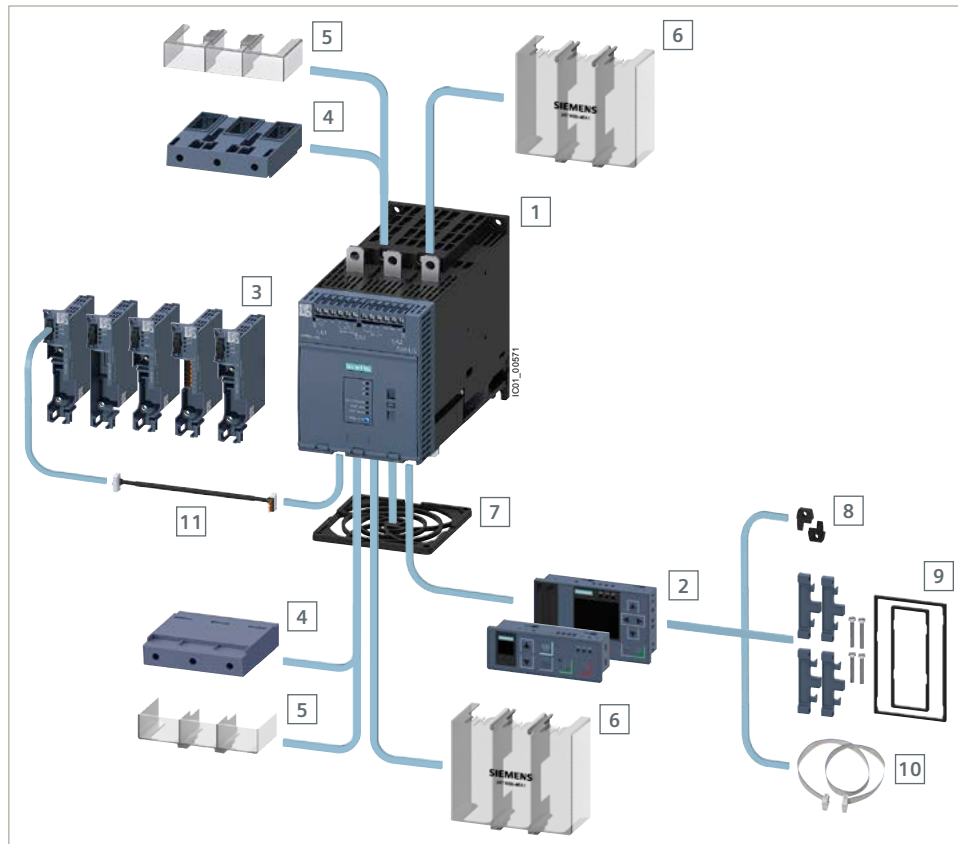

| Type | Manufacturer's article number of the soft starter | Version | Article No. | |
|------------------------------|---|----------------------------|--|---|
| 1 | 3RW50 soft starters | Standard | | |
| HMI modules | | | | |
| 2 | HMI module | 3RW50 | High-Feature Standard | 3RW5980-0HF00 3RW5980-0HS00 |
| Communication modules | | | | |
| 3 | Communication module | 3RW50 | PROFINET standard PROFIBUS EtherNet/IP Modbus RTU Modbus TCP | 3RW5980-0CS00 3RW5980-0CP00 3RW5980-0CE00 3RW5980-0CR00 3RW5980-0CT00 |
| Box terminal blocks | | | | |
| 4 | Box terminal block for round conductors and flat cables | 3RW505 (2x) | Up to 70 mm ² Up to 120 mm ² | 3RT1955-4G 3RT1956-4G |
| | | 3RW507 (2x) | Up to 240 mm ² (with control wire tap) | 3RT1966-4G |
| Terminal covers | | | | |
| 5 | Terminal covers for box terminals | 3RW505 (2x) 3RW507 (2x) | – | 3RT1956-4EA2 3RT1966-4EA2 |
| 6 | Cover for cable lug and bar connection | 3RW505 (2x) 3RW507 (2x) | – | 3RT1956-4EA1 3RT1966-4EA1 |
| Fan covers | | | | |
| 7 | Fan cover | 3RW50 (1x) | – | 3RW5985-0FC00 |
| Push-in lugs | | | | |
| 8 | Push-in lug for wall mounting | – | Two lugs are required per device | 3ZY1311-0AA00 |
| Mounting kits | | | | |
| 9 | IP65 door mounting kit for HMI modules | 3RW50 | IP65 | 3RW5980-0HD00 |
| Connecting cables | | | | |
| 10 | HMI connecting cable | 3RW50 | 5 m, round | 3RW5980-0HC60 |
| | | | 2.5 m, round | 3UF7933-0BA00-0 |
| | | | 1.0 m, round | 3UF7937-0BA00-0 |
| | | | 0.5 m, round | 3UF7932-0BA00-0 |
| 11 | COM connecting cable for mounting laterally on the device | 3RW50 | 0.3 m | 3RW5900-0CC00 |

**Published by
Siemens AG**

Smart Infrastructure
Werner-von-Siemens-Str. 48–50
92224 Amberg, Germany

**For the U.S. published by
Siemens Industry Inc.**

100 Technology Drive
Alpharetta, GA 30005
United States

Article No.: SICP-T10039-00-7600
Dispo 27601
WS 02203.0
Printed in Germany
© Siemens 2020

Subject to changes and errors. The information given in this document only contains general descriptions and/or performance features which may not always specifically reflect those described, or which may undergo modification in the course of further development of the products. The requested performance features are binding only when they are expressly agreed upon in the concluded contract.

All product designations may be trademarks or product names of Siemens AG or other companies whose use by third parties for their own purposes could violate the rights of the owners.

**You can find
more infor-
mation with
the QR code**

