

# SIEMENS

*Ingenuity for life*

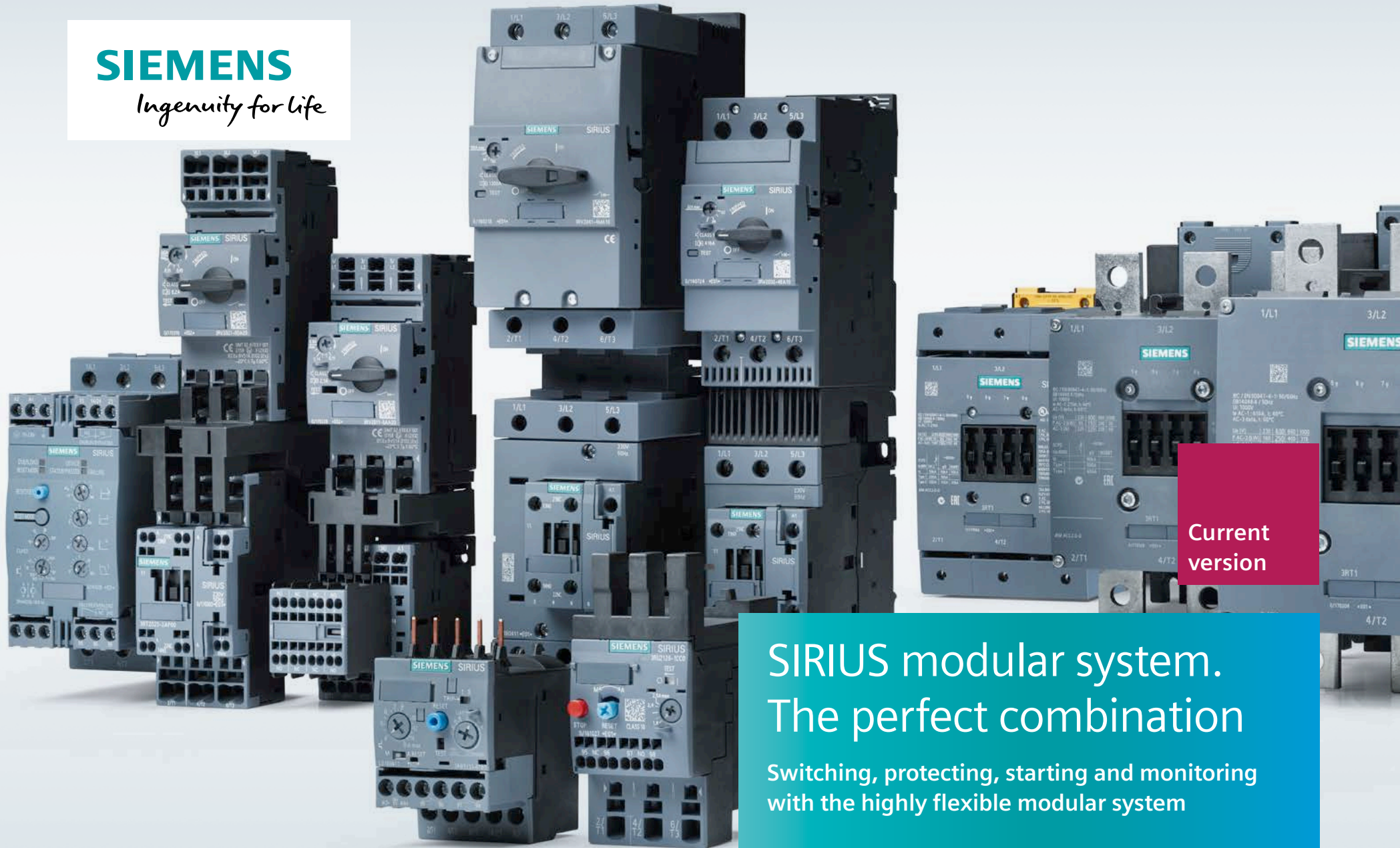

Current version

## SIRIUS modular system. The perfect combination

Switching, protecting, starting and monitoring  
with the highly flexible modular system

[siemens.com/sirius-modular-system](https://www.siemens.com/sirius-modular-system)

## Everything for the control cabinet: the SIRIUS modular system.

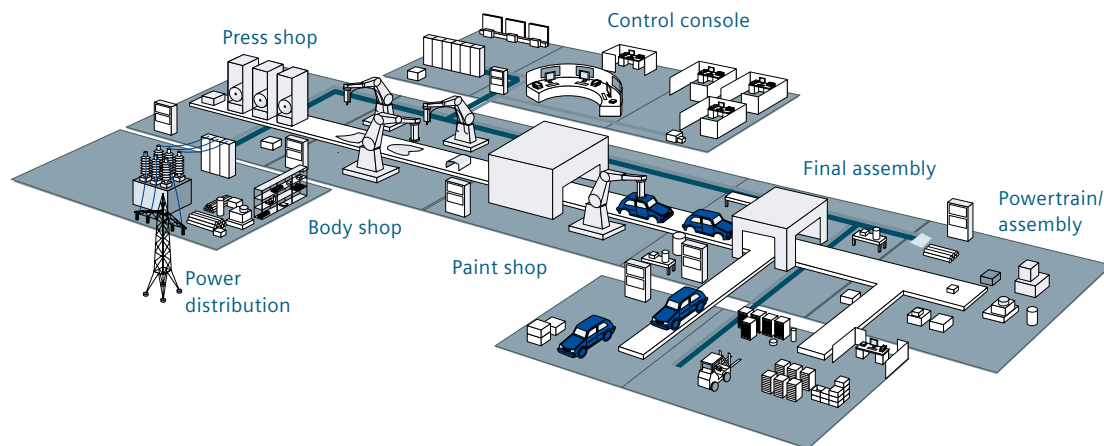

Processing, fitting, transporting. These and similar functions run on many automated production lines. With the extensive range of the SIRIUS modular system, you will find everything you need for switching, protecting, starting and monitoring motors.

**Everything. Really easy. With SIRIUS.**

### Contents

The components of the SIRIUS modular system	4
Combination of switching devices and protective devices	8
Convenient means of power supply and distribution	9
<b>Electromechanical switching devices for fuseless assembly of load feeders up to 7.5 kW</b>	10
<b>Size S00 selection and ordering data:</b>	
Motor starter protector, contactor with overload relay	10
Motor starter protector, contactor with current monitoring relay	10
Motor starter protector, soft starter with current monitoring relay	13
Motor starter protector, semiconductor contactor with current monitoring relay	13
<b>Electromechanical switching devices for fuseless assembly of load feeders up to 18.5 kW</b>	16
<b>Size S0 selection and ordering data:</b>	
Motor starter protector, contactor, overload relay	17
Motor starter protector, contactor with current monitoring relay	17
Motor starter protector, soft starter with current monitoring relay	18
<b>Assembly of direct-on-line starters and reversing starters 37 kW</b>	21
<b>Size S2 selection and ordering data:</b>	
Motor starter protector, contactor, overload relay	21
Motor starter protector, contactor with current monitoring relay	21
<b>Assembly of direct-on-line starters and reversing starters up to 55 kW</b>	27
<b>Size S3 selection and ordering data</b>	
<b>Size S6, S10 and S12</b>	31
<b>Selection and ordering data</b>	
<b>Fuseless load feeders</b>	
<b>Selection and ordering data:</b>	
Direct-on-line starters	34
(fully pre-assembled load feeders, compact starters)	
Reversing starters	35
(fully pre-assembled load feeders, compact starters)	
<b>Communication connection</b>	36
(IO-Link/AS-Interface master, contactors, function modules for mounting on 3RT2 contactors and for connecting to the automation level, compact starters)	
<b>Infeed systems</b>	39
For compact starters, load feeders, 3-phase busbar, 8US busbar adapter	
<b>Accessories</b>	
<b>Selection and ordering data:</b>	
Motor starter protectors	42
Contactors	43
Overload relays, current monitoring relays	48

# Everything. Systematically. SIRIUS modular system.

Building control cabinets must be fast, simple, flexible and space-saving. How can all this be achieved? With the unique SIRIUS modular system that offers everything you will need for switching, protecting, and starting motors and systems. In other words, it provides a modular range of standard components up to 250 kW/ 400 V in only seven sizes, which are perfectly matched to one another, can be combined really easily, and largely use the same accessories. That's how easy industrial controls can be!



Continuous further development and regular innovations ensure that our customers are optimally equipped with SIRIUS and benefit from efficient solutions – now and in the future. All the components that make up the SIRIUS modular system are characterized by a space-saving design and a high degree of flexibility. Configuring, installing, wiring and maintenance are extremely easy and time-saving to perform. So no matter whether you want to configure load feeders with motor starter protectors, overload relays, contactors/solid-state contactors or soft starters, SIRIUS has just the product you will need for any application.

Thanks to the latest innovations to the modular system in sizes S00, S0, S2 and S3 up to 115 A, today's SIRIUS modular system shows even more functional diversity.

In addition to the basic components, the innovated SIRIUS modular system offers new, never-before-seen highlights:

- Feeder assemblies that can be plugged in completely without tools thanks to the consistent use of spring-loaded connections in sizes S00 and S0
- 2- and 3-phase 3RR2 monitoring relays for current monitoring for direct mounting on contactors (up to size S2)
- 3RA27 and 3RA28 function modules feature snap-on connection to contactors enabling the easiest possible assembly of direct-on-line starters, reversing starters, and star-delta (wye-delta) starting, and connection to the controller using less wiring via AS-Interface or IO-Link
- 3RB24 overload relay with communication capability, current value transmission, and control of the contactors via IO-Link
- One highlight of the SIRIUS devices is their IE3 and IE4 suitability, so that they are optimally equipped for conversion to the new IE3 and IE4 generation of motors

## At a glance. The components of the SIRIUS modular system offer a host of benefits.

With its wide range of components, the SIRIUS modular system features the most diverse functions for use in the control cabinet, and offers a host of benefits in assembly and handling, in application monitoring, and also in controller interfacing, or when planning and configuring.



### Assembly and handling:

Error prevention and reduced wiring effort – with maximum flexibility

- **Load feeders:** easy to implement up to 250 kW/400 V from standard devices
- **Modular design:** everything fits together and can be combined
- **Variants and sizes:** economical and flexible thanks to 7 compact sizes
- **Accessories:** low variance with uniform accessories
- **Configuration:** fast commissioning, short setting-up times, and simple wiring
- **Mounting:** permanently secure mounting, with screw terminals or simply by plugging in
- **Spring-loaded connection system:** quick and secure connection, vibration-proof, and maintenance-free
- **Reduced wiring:** significant reductions in cable connections thanks to plug-in design and IO-Link or AS-Interface

### Applications at a glance:

Increased operational reliability and system availability

- **Maintenance:** extremely durable, low maintenance, and reliable
- **Application monitoring:** integrated extremely flexibly into the feeder – thanks to monitoring relays for current monitoring
- **IE3/IE4-ready:** With the SIRIUS modular system, we also offer you our familiar reliability when converting to IE3 and IE4 motors

### Connection to the automation level:

Optimal integration into the automation environment

- **Communication:** standardized connection to AS-Interface, IO-Link and PROFIBUS DP possible

### Planning and configuration:

Simplified system planning and documentation

- **Configuration:** easy and fast thanks to extensive CAx data provision
- **Service:** short delivery times even for spare parts thanks to global logistics network
- **Environment:** environmentally friendly production and materials, recyclable
- **Design:** clear, ergonomic design (winner of the iF Product Design Award)
- **Configurator:** for the simplest possible selection of products including accessories
- **Global use:** thanks to comprehensive approvals



# Switching. Protecting. Starting. Monitoring.

## The components of the SIRIUS modular system.



### Much more than ON/OFF: SIRIUS 3RV motor starter protectors

The SIRIUS 3RV motor starter protectors are compact, current-limiting motor starter protectors. They ensure secure disconnection in case of a short-circuit and protect loads and the plant against overloads. They are also suited to functional switching of loads with a low frequency of operation, and for protective separation of the system from the power supply during maintenance work or modifications. For applications over 100 A, SENTRON 3VA circuit breakers are suitable.



### Rugged and reliable: SIRIUS 3RT contactors

Thanks to their extreme ruggedness and outstanding contact reliability, our contactors switch supremely and reliably. In addition, they enable compact control cabinets with high packing density. With integrated ranges of accessories for sizes S00 to S3 as well as S6 to S12, individual function expansions can be implemented with no great effort. In sizes S00 to S3, the contactors even have the auxiliary switches integrated into the enclosure.



### Tripping when things get serious: SIRIUS 3RU and 3RB overload relays

The overload relays of the SIRIUS family are available in thermal and electronic versions, and they are responsible for the inverse-time-delayed overload protection in the main circuit. The SIRIUS 3RB electronic overload relays ensure seamless protection for motors and systems from 0.1 A to 630 A. This current range can be covered with a minimum number of variants thanks to the large setting range.



### Simplest possible application monitoring: SIRIUS 3RR2 current monitoring relays

The SIRIUS current monitoring relays monitor not so much the motor as the entire plant or driven process for overcurrent and undercurrent, wire break, or phase failure. Thus, load shedding or overload of an application, for example, is detected quickly and reported early. The 3RR2 monitoring relay for current monitoring is integrated directly into the load feeder in sizes S00, S0 and S2. Just attach it to the contactor, and click 'n' go.



### Soft starting: SIRIUS 3RW soft starters

The SIRIUS 3RW soft starters offer a complete range that covers all basic performance applications of motor starting. Thus, the benefits of soft starting can be reaped in the most diverse applications up to 315 kW (at 400 V) for simple and economical implementation of optimum machine concepts. Economical and space-saving soft starting can be implemented up to 55 kW (at 400 V) with the compact 3RW30 with two-phase control. The 3RW40 also offers smooth ramp-down as well as integrated intrinsic device protection functions and motor protection functions. The 3RW50 also offer integration into the TIA Portal with optional communication modules and HMI modules. SIRIUS soft starters are available for line voltages up to 600 V – optionally also with thermistor motor protection evaluation.

## Switching. Protecting. Starting. Monitoring. The components of the SIRIUS modular system.



### Master the highest switching frequencies with confidence: SIRIUS 3RF solid-state contactors

SIRIUS solid-state contactors (size S0) for switching motors impress with their almost limitless service life – even under harsh conditions and at high switching frequencies. The three-phase solid-state contactors switch motors completely silently up to 7.5 kW.

A special reversing contactor version enables changing of the direction of rotation of motors up to 3 kW. The compact devices in widths of 45 or 90 mm can be combined with our motor starter protectors, current monitoring relays, or electronic overload relays. For fast and simple assembly of fuseless and fused motor feeders.



### Compact switching and protecting: SIRIUS 3RA6 compact starters and 3RM1 motor starters

Equipped with the functions of a motor starter protector, a contactor, and an electronic overload relay, the 3RA6 compact starter as a direct-on-line or reversing starter up to 32 A offers maximum reliability with minimum variance. There is reduced wiring in the main circuit thanks to the ingeniously simple infeed system, including PE connection. Thanks to the optional AS-Interface or integrated IO-Link interface, 3RA6 compact starters are integrated into the Totally Integrated Automation design concept.

The 3RM1 direct-on-line or reversing starters up to 7 A reduce width even further to one half the previous size, and are thus master space-savers. Fail-safe design versions offer the greatest possible economizing on switching device deployment in safety-related applications.

SIRIUS contactor with spring-loaded terminals



### Faster wiring thanks to integrated spring-loaded terminals

All products with 45-mm widths (S00- and S0-size series) in the main as well as auxiliary and control circuits are available with spring-loaded terminals in addition to the conventional screw terminals. This accelerates device connection, and offers maximum operational safety and reliability. The extremely simple wiring guarantees fast installation. Another advantage is that the gas-tight terminal connection is resistant to shaking and vibration. In addition, you benefit from maximum contact reliability – even under the harshest of conditions. There's no need to subsequently re-tighten the connection terminals (often the usual practice). One particular advantage is that the link modules for direct-on-line, reversing and star-delta (wye-delta) starting are also available with spring-loaded terminals. This enables you to install entire feeders entirely without tools. Spring-loaded terminals in the auxiliary circuit are optionally available in sizes S2 and S3.

SIRIUS contactor with screw terminals



### Maximum flexibility when it comes to connections

All the components of the SIRIUS modular system are, of course, also available with screw terminals for special requirements such as mechanical engineering in the semiconductor industry. In sizes with design widths of 70 mm and larger (i.e. as of size S3), additional possible connection options are available such as for connecting cable terminal lugs to device connection bars, or connecting cables with large cross sections to box terminals.

# Switching. Protecting. Starting. Monitoring. The components of the SIRIUS modular system.



Straight to the point:  
the 3RA21 direct-on-line starter



Phases swapped:  
the 3RA22 reversing starter



Two stages – one start:  
the 3RA24 contactor  
assembly for star-delta start

## Ready for immediate use: pre-wired SIRIUS load feeders

Load feeders start loads with a combination of protection and switching functions. To reduce time and costs, and above all to minimize standstill times, we offer you a wide range of pre-wired starter solutions:

- Direct-on-line starters up to 30 kW and reversing starters up to 15 kW – the right starter combination for all motors – both for standard rail mounting and with 60 mm standard mounting rail adapters.
- Reversing contactor assemblies up to 55 kW – the appropriate combination for reversing duty – for fast rotation direction changes of motors
- Contactor assemblies for star-delta starting up to 90 kW – the solution for starting in stages for reducing start-up current peaks of motors.
- Soft starters – when soft starting and smooth ramp-down are required (in the case of the 3RW40 and 3RW50 even with integral overload protection)

An almost unlimited number of further tested combinations can be assembled easily from the individual components. The following manuals help you to make your selection, and they can be found in the Industry Online Support Portal at <http://support.automation.siemens.com>.

### **SIRIUS modular system**

Configuration Manual "Configuring the SIRIUS Modular System – Selection Data for Fuseless and Fused Load Feeders"

### **Configuration instructions for IE3 and IE4 motors**

Application manual for SIRIUS switching devices with IE3 and IE4 motors

# Combination of switching devices and protective devices

Electromechanical switching devices	Contactor and overload relay with fuse	Motor starter protector for motor protection and contactor	Motor starter protector for motor protection with relay function and contactor	Motor starter protector for starter protection, contactor and overload relay	Compact starter	Motor starter protector for motor protection, contactor and current monitoring relay	Motor starter protector for motor protection with relay function, contactor and current monitoring relay
Short circuit							
Overload							
Switching							
Monitoring							
	Fused	Fuseless					

Solid-state switching devices	Mot. starter protector for motor protection, solid-state switching device (soft starter or solid-state contactor) and curr. monit. relay	Fuse and soft starter	Fuse, solid-state switching device and current monitoring relay	Motor starter protector for motor protection and solid-state switching device (soft starter or solid-state contactor)	Motor starter protector for motor protection, 3RM1 motor starter
Short circuit					
Overload					
Switching					
Monitoring					
	Fuseless	Fused		Fuseless	



## Convenient power infeed and distribution: SIRIUS 3RV29 and 3RA68 infeed systems.

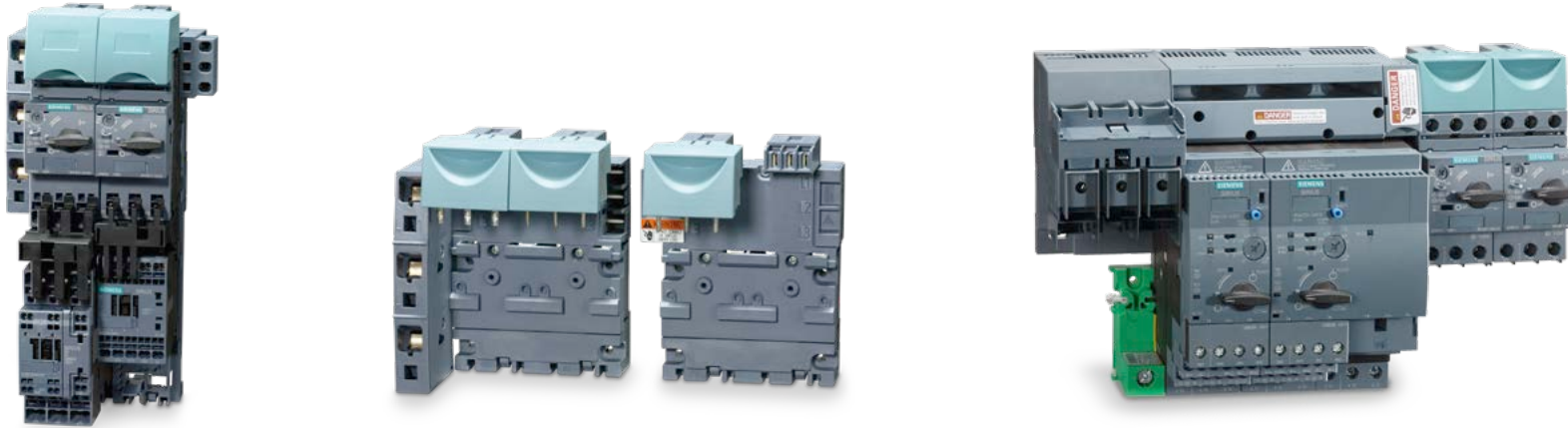

### Efficient and flexible power distribution

The components of the SIRIUS modular system can be wired extremely flexibly. For sizes S00 and S0, the simplest method is to connect the components via the associated SIRIUS 3RV29 infeed system in each case. Alongside this, the 3RA68 infeed system is available in conjunction with the 3RA6 compact starter – and both connection methods are available optionally for devices with screw and spring-loaded terminals. Individual motor starter protectors, complete load feeders, and compact starters are just clicked into the infeed systems. An entire feeder group is thus supplied with energy without any time-consuming wiring and with no risk of error – just click and go!

Alternatively, you can also use conventional wiring: by means of parallel wiring, 3-phase busbars or 8US busbar adapters

with which SIRIUS load feeders can be mounted directly on a 60 mm busbar system.

These diverse combination options provide you with the most effortless solution to implement your individual control cabinets – simply perfectly tailored to your application.

### Assembly – Highlights

- Consistent use throughout by combining 3RV29 and 3RA68 modules
- New flexibility for installation and expansion
- More free space in the control cabinet – thanks to extremely compact design
- Infeed (3RA68) either on the left or right with conductor cross section up to 70 mm<sup>2</sup>
- Optional wiring channel between the feeders
- Additional integration of further 1-, 2- or 3-pole components via terminal block
- Maximum current carrying capacity of 100 A (3RA68)
- Integration of load feeders with screw and spring-loaded terminals
- High vibration resistance, especially for switching devices with spring-loaded terminals
- Time savings during installation thanks to simple plug-in design
- For 3RA68 infeed system also with PE connection option

Motor starter protector for starter protection, contactor with overload relay

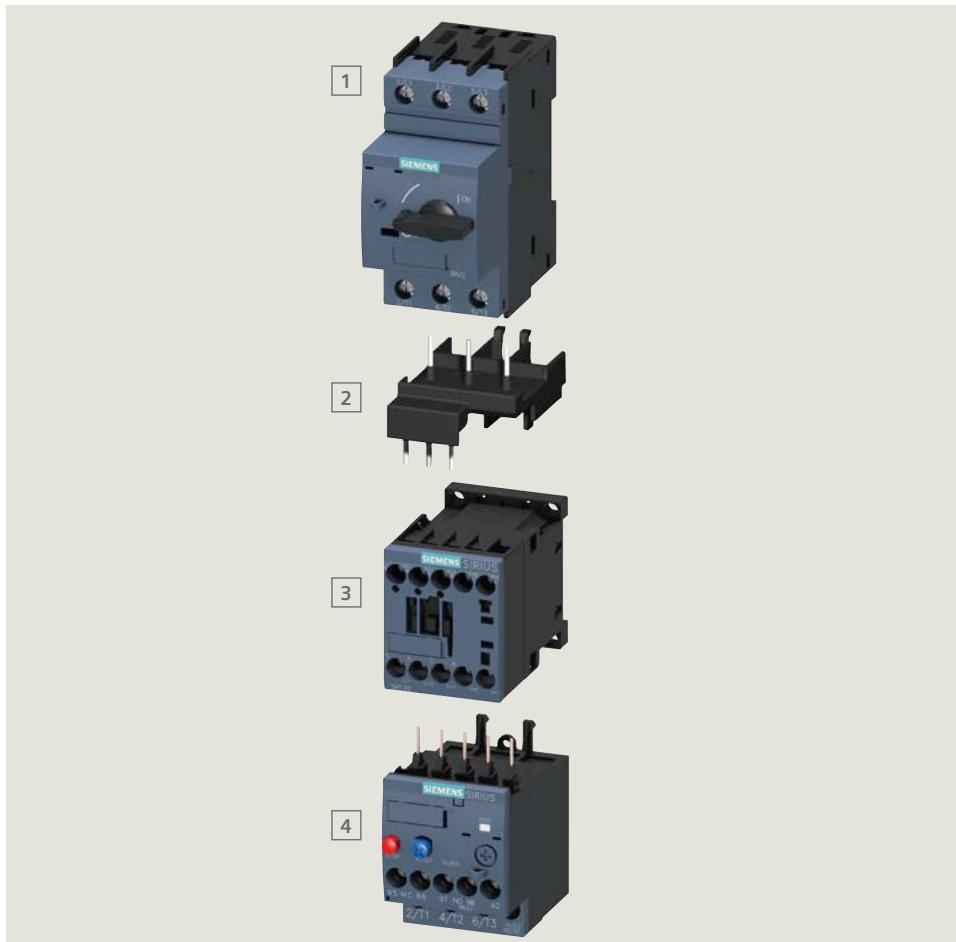

Type	Screw terminals	Spring-loaded terminals
1 Motor starter protector	3RV2311-□□□1□	3RV2311-□□□2□
2 Link module	3RA1921-1DA00	3RA2911-2AA00
3 Contactor (AC/DC)	3RT201□-1□□□□	3RT201□-2□□□□
4 Overload relay	3RU2116-□□B0 or 3RB3□1□-□□B0	3RU2116-□□C0 3RB3016-□□E0

Motor starter protector for motor protection, contactor with current monitoring relay

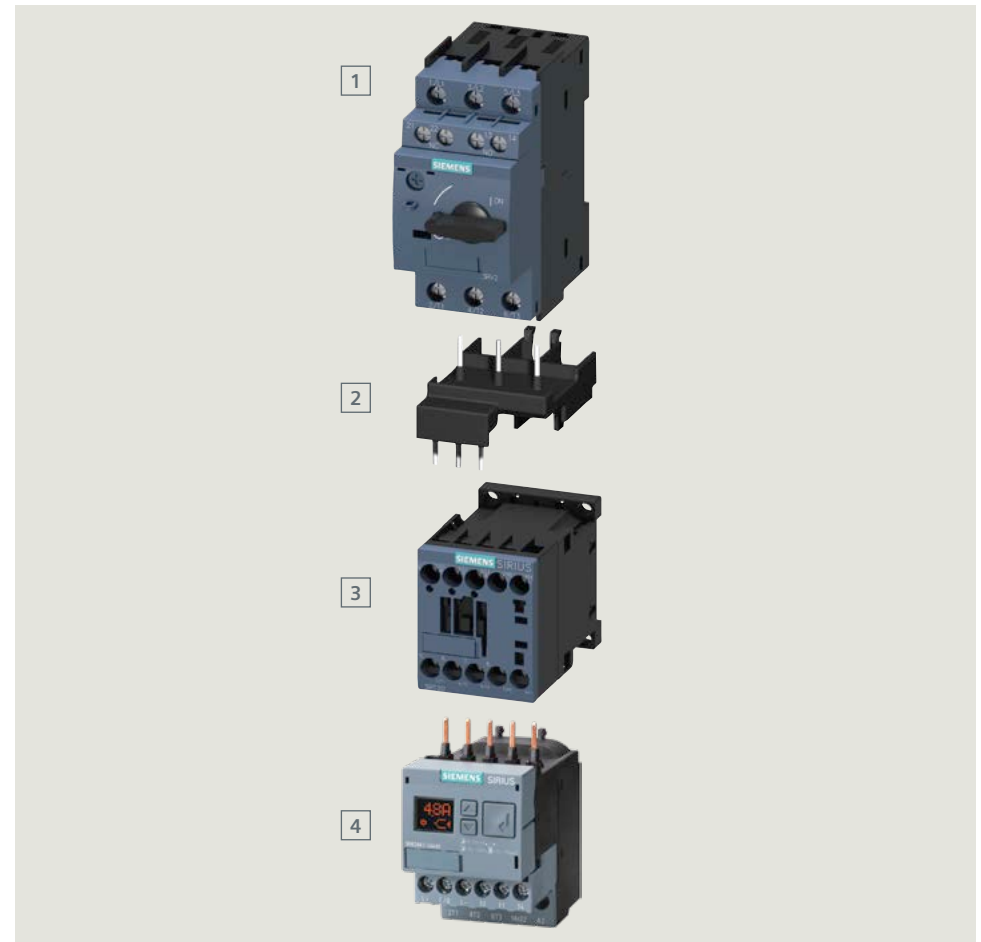

Type	Screw terminals	Spring-loaded terminals
1 Motor starter protector	3RV2011-□□□1□	3RV2011-□□□2□
2 Link module	3RA1921-1DA00	3RA2911-2AA00
3 Contactor (AC/DC)	3RT201□-1□□□□	3RT201□-2□□□□
4 Current monitoring relay	3RR2□41-1□□□□	3RR2□41-2□□□□

# Starter combinations in size S00: motor starter protector for starter protection, contactor and overload relay

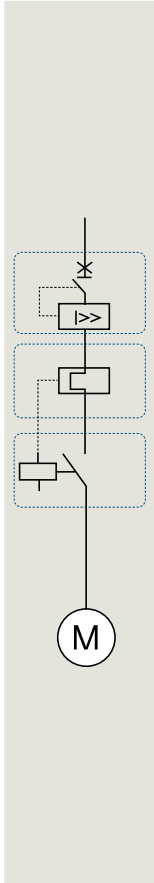

Standard three-phase motor 4-pole at 400 V AC

[kW]	[A]
0.04	0.16
0.06	0.20
0.06	0.20
0.09	0.30
0.09	0.30
0.12	0.44
0.18	0.60
0.18	0.60
0.25	0.85
0.37	1.10
0.55	1.50
0.75	1.90
0.75	1.90
1.1	2.70
1.5	3.60
1.5	3.60
2.2	4.90
3	6.50
4	8.50
5.5	11.5
7.5	15.5



## MSPs for starter protection

MSP rated current [A]	Article No.
0.16	3RV2311-0AC□0
0.2	3RV2311-0BC□0
0.25	3RV2311-0CC□0
0.32	3RV2311-0DC□0
0.4	3RV2311-0EC□0
0.5	3RV2311-0FC□0
0.63	3RV2311-0GC□0
0.8	3RV2311-0HC□0
1	3RV2311-0JC□0
1.25	3RV2311-0KC□0
1.6	3RV2311-1AC□0
2	3RV2311-1BC□0
2.5	3RV2311-1CC□0
3.2	3RV2311-1DC□0
4	3RV2311-1EC□0
5	3RV2311-1FC□0
6.3	3RV2311-1GC□0
8	3RV2311-1HC□0
10	3RV2311-1JC□0
12.5	3RV2311-1KC□0
16	3RV2311-4AC□0

Screw terminals: 1  
Spring-loaded terminals: 2



## Contactors (aux. contacts 1NO or 1NC integrated)

Rated operational current [A]	Article No. 24 V DC	Article No. 230 V AC, 50/60 Hz
7	3RT2015-□BB4□	3RT2015-□AP0□
9	3RT2016-□BB4□	3RT2016-□AP0□
12	3RT2017-□BB4□	3RT2017-□AP0□
16	3RT2018-□BB4□	3RT2018-□AP0□

Screw terminals: 1  
Spring-loaded terminals: 2  
1NO: 1  
1NC: 2

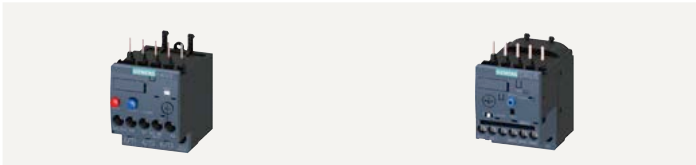

## Overload relays

Setting range [A]	Article No. thermal overload relay CLASS 10	Setting range [A]	Article No. electronic overload relay CLASS 10E
0.11 – 0.16	3RU2116-0A □0	0.1 – 0.4	3RB3016-1R □0
0.14 – 0.2	3RU2116-0B □0		
0.18 – 0.25	3RU2116-0C □0		
0.22 – 0.32	3RU2116-0D □0		
0.28 – 0.4	3RU2116-0E □0	0.32 – 1.25	3RB3016-1N □0
0.35 – 0.5	3RU2116-0F □0		
0.45 – 0.63	3RU2116-0G □0		
0.55 – 0.8	3RU2116-0H □0		
0.7 – 1	3RU2116-0J □0	1 – 4	3RB3016-1P □0
0.9 – 1.25	3RU2116-0K □0		
1.1 – 1.6	3RU2116-1A □0		
1.4 – 2	3RU2116-1B □0		
1.8 – 2.5	3RU2116-1C □0	3 – 12	3RB3016-1S □0
2.2 – 3.2	3RU2116-1D □0		
2.8 – 4	3RU2116-1E □0		
3.5 – 5	3RU2116-1F □0		
4.5 – 6.3	3RU2116-1G □0	4 – 16	3RB3016-1T □0
5.5 – 8	3RU2116-1H □0		
7 – 10	3RU2116-1J □0		
9 – 12.5	3RU2116-1K □0		
11 – 16	3RU2116-4A □0		

Screw terminals: B  
Spring-loaded terminals: C  
Screw terminals: E  
Spring-loaded terminals: F

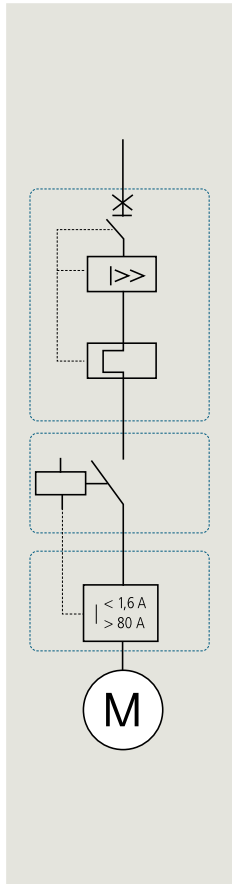

Standard three-phase motor 4-pole at 400 V AC

[kW]	[A]
0.04	0.16
0.06	0.20
0.06	0.20
0.09	0.30
0.09	0.30
0.12	0.44
0.18	0.60
0.18	0.60
0.25	0.85
0.37	1.10
0.55	1.50
0.75	1.90
0.75	1.90
1.1	2.70
1.5	3.60
1.5	3.60
1.5	4.90
3	6.50
4	8.50
5.5	11.5
7.5	15.5



**MSPs for motor protection**

Setting range for thermal overload release  
CLASS 10

[A]	Article No.
0.11 – 0.16	3RV2011-0AA□0
0.14 – 0.2	3RV2011-0BA□0
0.18 – 0.25	3RV2011-0CA□0
0.22 – 0.32	3RV2011-0DA□0
0.28 – 0.4	3RV2011-0EA□0
0.35 – 0.5	3RV2011-0FA□0
0.45 – 0.63	3RV2011-0GA□0
0.55 – 0.8	3RV2011-0HA□0
0.7 – 1	3RV2011-0JA□0
0.9 – 1.25	3RV2011-0KA□0
1.1 – 1.6	3RV2011-1AA□0
1.4 – 2	3RV2011-1BA□0
1.8 – 2.5	3RV2011-1CA□0
2.2 – 3.2	3RV2011-1DA□0
2.8 – 4	3RV2011-1EA□0
3.5 – 5	3RV2011-1FA□0
4.5 – 6.3	3RV2011-1GA□0
5.5 – 8	3RV2011-1HA□0
7 – 10	3RV2011-1JA□0
9 – 12.5	3RV2011-1KA□0
10 – 16	3RV2011-4AA□0

Screw terminals: 1  
Spring-loaded terminals: 2



**Contactors (aux. contacts 1NO or 1NC integrated)**

Rated operational current [A]	Article No.	
	Control supply voltage	
	DC 24 V	230 V AC, 50/60 Hz
7	3RT2015-□BB4□	3RT2015-□AP0□
9	3RT2016-□BB4□	3RT2016-□AP0□
12	3RT2017-□BB4□	3RT2017-□AP0□
16	3RT2018-□BB4□	3RT2018-□AP0□

Screw terminals: 1  
Spring-loaded terminals: 2

1NO: 1  
1NC: 2



**Current monitoring relays**

Meas. range [A]	Article No.	
	Basic (analog adjustable)	Standard (digital adjustable)*
1.6 – 16	3RR2141-□A□30	3RR2241-□F□30

Screw terminals: 1  
Spring-loaded terminals: 2

24 V AC/DC: A  
24 – 240 V AC/DC: W

Screw terminals: 1  
Spring-loaded terminals: 2

24 V AC/DC: A  
24 – 240 V AC/DC: W

\*likewise available as 3RR24 with IO-Link



## Fuseless assembly with solid-state switching devices

### Assembly up to 7.5 kW (S00)

Motor starter protector for motor protection, soft starter with current monitoring relay (stand-alone installation)



<sup>1)</sup> The terminal support for stand-alone assembly is needed to use a 3RR2 current monitoring relay on a 3RW30/40 soft starter. In the starting and stopping phase (generalized phase control), the current monitoring relay shall not be active. For 3RW30: Activate the 3RR2 monitoring relay via an upstream timing relay after the end of the soft start. For 3RW40: Activate and deactivate the 3RR2 monitoring relay via the BYPASS output (ramp-up detection).

Type	Screw terminals	Spring-loaded terminals
1 Motor starter protector	3RV2011-□□□□1□	3RV2011-□□□□2□
2 Link module	3RA2921-1BA00	3RA2911-2GA00
3 Soft starter	3RW301□-1□□□□□	3RW301□-2□□□□□
4 Terminal support stand-alone	3RU2916-3AA01	3RU2916-3AC01
5 Current monitoring relay <sup>1)</sup>	3RR2□41-1□□□□□	3RR2□41-2□□□□□

Motor starter protector for motor protection, solid-state contactor with current monitoring relay (stand-alone installation)



<sup>1)</sup> The terminal support for stand-alone assembly is needed to use a size-S00 3RR2\*41 current monitoring relay with a semiconductor contact.

Type	Screw terminals	Spring-loaded terminals
1 Motor starter protector	3RV2011-□□□□1□	
2 Link module	3RA2921-1BA00	
3 Solid-state cont./solid-state rev. cont.	3RF34□□-1□□□□□	
4 Terminal support stand-alone	3RU2916-3AA01	3RU2916-3AC01
5 Current monitoring relay <sup>1)</sup>	3RR2□□-1□□□□□	3RR2□41-2□□□□□

# Starter combinations: Motor starter protector for motor protection, soft starter with current monitoring relay

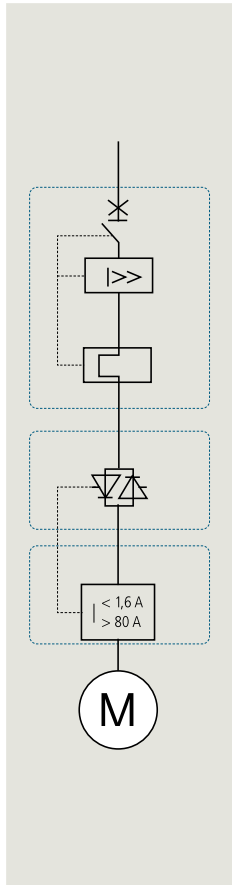



Standard three-phase motor 4-pole at 400 V AC	
[kW]	[A]
0.04	0.16
0.06	0.20
0.06	0.20
0.09	0.30
0.09	0.30
0.12	0.44
0.18	0.60
0.18	0.60
0.25	0.85
0.37	1.10
0.55	1.50
0.75	1.90
0.75	1.90
1.1	2.70
1.5	3.60
1.5	3.60
2.2	4.90
3	6.50
4	8.50
5.5	11.5
7.5	15.5



Motor starter protectors	
Setting range for thermal overload release CLASS 10	
[A]	Article No.
0.11 – 0.16	3RV2011-0AA□0
0.14 – 0.2	3RV2011-0BA□0
0.18 – 0.25	3RV2011-0CA□0
0.22 – 0.32	3RV2011-0DA□0
0.28 – 0.4	3RV2011-0EA□0
0.35 – 0.5	3RV2011-0FA□0
0.45 – 0.63	3RV2011-0GA□0
0.55 – 0.8	3RV2011-0HA□0
0.7 – 1	3RV2011-0JA □0
0.9 – 1.25	3RV2011-0KA□0
1.1 – 1.6	3RV2011-1AA□0
1.4 – 2	3RV2011-1BA□0
1.8 – 2.5	3RV2011-1CA□0
2.2 – 3.2	3RV2011-1DA□0
2.8 – 4	3RV2011-1EA□0
3.5 – 5	3RV2011-1FA□0
4.5 – 6.3	3RV2011-1GA□0
5.5 – 8	3RV2011-1HA□0
7 – 10	3RV2011-1JA □0
9 – 12.5	3RV2011-1KA□0
10 – 16	3RV2011-4AA□0



Soft starters <sup>1)</sup>		
Rated operational current [A]	Article No.	
	24 V DC	230 V AC, 50/60 Hz
3.6	3RW3013-□BB04	3RW3013-□BB14
6.5	3RW3014-□BB04	3RW3014-□BB14
9	3RW3016-□BB04	3RW3016-□BB14
12.5	3RW3017-□BB04	3RW3017-□BB14
17.6	3RW3018-□BB04	3RW3018-□BB14

Current monitoring relays		
Meas. range [A]	Article No.	
	Basic (analog adjustable)	Standard (digital adjustable)*
1.6 – 16	3RR2141-□A□30	3RR2241-□F□30

<sup>1)</sup> Rated operational voltage 200 – 480 V

Screw terminals: ①  
Spring-loaded terminals: ②

Screw terminals: ①  
Spring-loaded terminals: ②

Screw terminals: ①  
Spring-loaded terminals: ②  
24 V AC/DC: ③  
24 – 240 V AC/DC: ④

Screw terminals: ①  
Spring-loaded terminals: ②  
24 V AC/DC: ③  
24 – 240 V AC/DC: ④

\*likewise available as 3RR24 with IO-Link

# Starter combinations: motor starter protector for motor protection, solid-state switching device and current monitoring relay

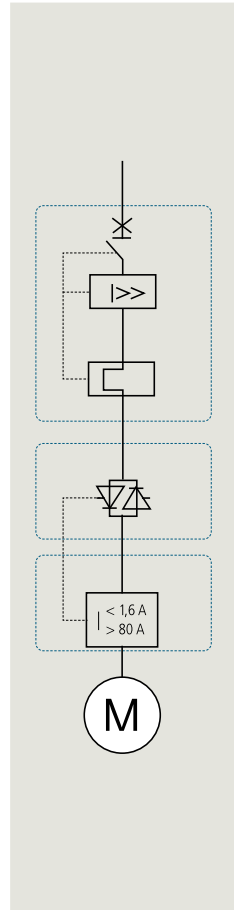

Standard three-phase motor 4-pole at 400 V AC	
[kW]	[A]
0.04	0.16
0.06	0.20
0.06	0.20
0.09	0.30
0.09	0.30
0.12	0.44
0.18	0.60
0.18	0.60
0.25	0.85
0.37	1.10
0.55	1.50
0.75	1.90
0.75	1.90
1.1	2.70
1.5	3.60
1.5	3.60
2.2	4.90
3	6.50
4	8.50
5.5	11.5
7.5	15.5



Motor starter protectors	
Setting range for thermal overload release CLASS 10	
[A]	Article No.
0.11 – 0.16	3RV2011-0AA□0
0.14 – 0.2	3RV2011-0BA□0
0.18 – 0.25	3RV2011-0CA□0
0.22 – 0.32	3RV2011-0DA□0
0.28 – 0.4	3RV2011-0EA□0
0.35 – 0.5	3RV2011-0FA□0
0.45 – 0.63	3RV2011-0GA□0
0.55 – 0.8	3RV2011-0HA□0
0.7 – 1	3RV2011-0JA□0
0.9 – 1.25	3RV2011-0KA□0
1.1 – 1.6	3RV2011-1AA□0
1.4 – 2	3RV2011-1BA□0
1.8 – 2.5	3RV2011-1CA□0
2.2 – 3.2	3RV2011-1DA□0
2.8 – 4	3RV2011-1EA□0
3.5 – 5	3RV2011-1FA□0
4.5 – 6.3	3RV2011-1GA□0
5.5 – 8	3RV2011-1HA□0
7 – 10	3RV2011-1JA□0
9 – 12.5	3RV2011-1KA□0
10 – 16	3RV2011-4AA□0

Screw terminals: 1  
Spring-loaded terminals: 2



Solid-state contactors <sup>2)</sup>		
Rated operational current [A]	Article No.	Article No.
	Control supply voltage	
	24 V DC	110 – 230 V AC, 50/60 Hz
5.2	3RF3405-□BB04	3RF3405-□BB24
9.2	3RF3410-□BB04 <sup>1)</sup>	3RF3410-□BB24 <sup>1)</sup>
12.5	3RF3412-□BB04 <sup>1)</sup>	3RF3412-□BB24 <sup>1)</sup>
16	3RF3416-□BB04 <sup>1)</sup>	3RF3416-□BB24 <sup>1)</sup>

Screw terminals: 1  
Spring-loaded terminals: 2

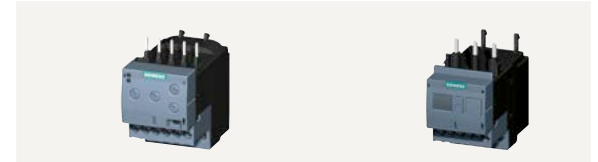

Current monitoring relays		
Meas. range [A]	Article No. Basic (analog adjustable)	Article No. Standard (digital adjustable)*
	1.6 – 16	3RR2141-□A□30 <sup>3)</sup>

Screw terminals: 1  
Spring-loaded terminals: 2  
24 V AC/DC: A  
24 – 240 V AC/DC: M

\*likewise available as 3RR24 with IO-Link

Solid-state reversing contactors <sup>2)</sup>		
3.8	3RF3403-1BD04	3RF3403-1BD24
5.4	3RF3405-1BD04	3RF3405-1BD24
7.4	3RF3410-1BD04 <sup>1)</sup>	3RF3410-1BD24 <sup>1)</sup>

<sup>1)</sup> Width 90 mm

<sup>2)</sup> Rated operational voltage U<sub>e</sub> 48 – 480 V

<sup>3)</sup> Can be mounted directly on solid-state contactor with screw terminals using connection adapter 3RF3900-0QA88

## Fuseless assembly Assembly 18.5 kW (S0)

Motor starter protector for starter protection, contactor and overload relay

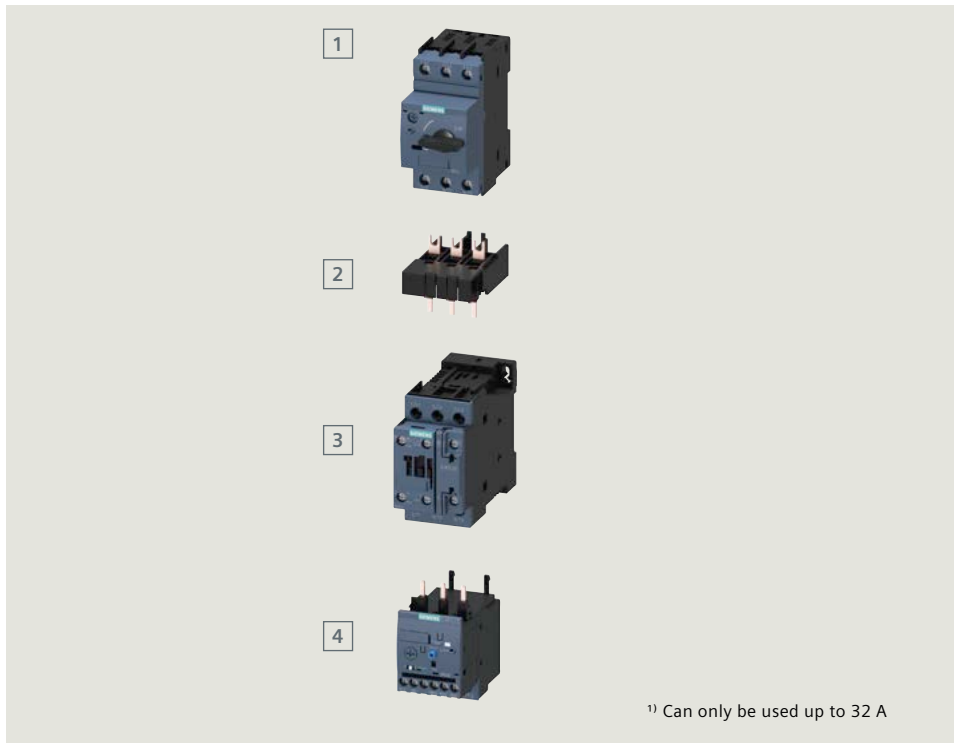

Type	Screw terminals	Spring-loaded terminals
1 Motor starter protector	3RV2321-□□□1□	3RV2321-□□□2□
2 Link module <sup>1)</sup>	AC 3RA2921-1AA00 DC 3RA2921-1BA00	3RA2921-2AA00 3RA2921-2AA00
3 Contactor	3RT202□-1□□□□	3RT202□-2□□□□
4 Overload relay	3RU2126-□□□B0 or 3RB3□2□-□□□B0	3RU2126-□□□C0 or 3RB3□2□-□□□E0

Motor starter protector for motor protection, contactor with current monitoring relay

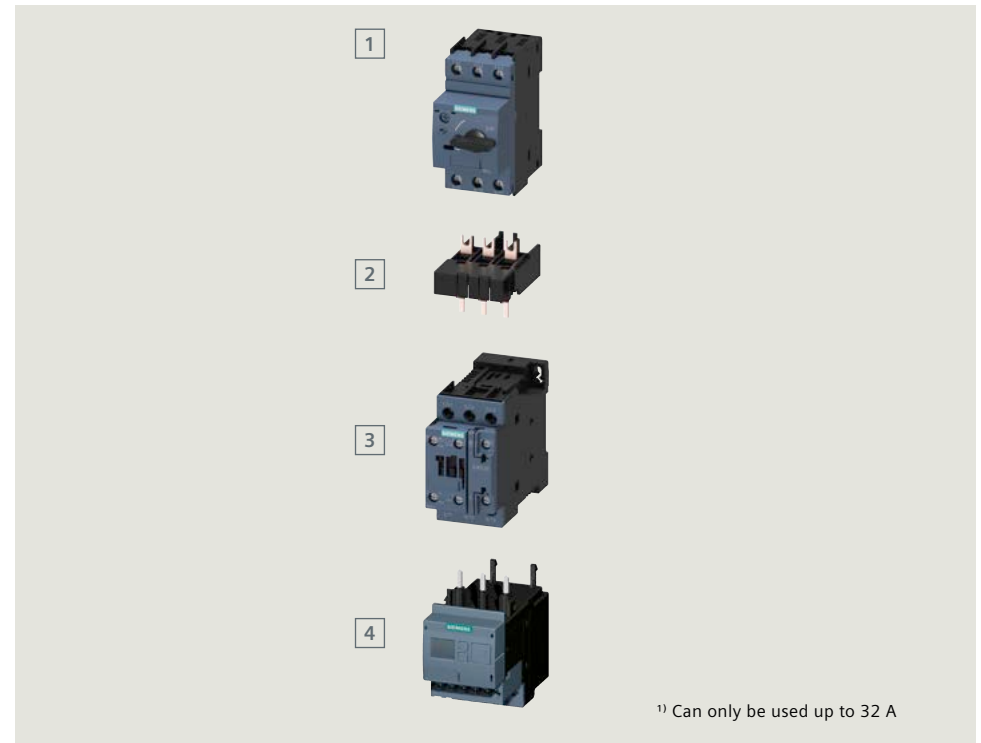

Type	Screw terminals	Spring-loaded terminals
1 Motor starter protector	3RV2021-□□□1□	3RV2021-□□□2□
2 Link module <sup>1)</sup>	AC 3RA2921-1AA00 DC 3RA2921-1BA00	3RA2921-2AA00 3RA2921-2AA00
3 Contactor	3RT202□-1□□□□	3RT202□-2□□□□
4 Current monitoring relay	3RR2□42-1□□□□	3RR2□42-2□□□□



## Starter combinations size S0: Motor starter protector for starter protection, contactor and overload relay

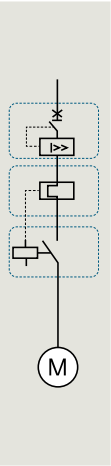

Standard three-phase motor 4-pole at 400 V AC	
[kW]	[A]
7.5	15.5
7.5	15.5
11	22
11	22
15	29
15	29
18.5	35
18.5	35

MSPs for starter protection	
MSP rated current [A]	Article No.
16	3RV2321-4AC□0
20	3RV2321-4BC□0
22	3RV2321-4CC□0
25	3RV2321-4DC□0
28	3RV2321-4NC□0
32	3RV2321-4EC□0
36	3RV2321-4PC10
40	3RV2321-4FC10

Contactors (auxiliary contacts 1NO or 1NC integrated)			
Rated operational current [A]	Article No.		
	Control supply voltage		
	24 V DC	230 V AC, 50 Hz	50/60 Hz AC/DC
17	3RT2025-□BB40	3RT2025-□AP00	3RT2025-□N□30
25	3RT2026-□BB40	3RT2026-□AP00	3RT2026-□N□30
32	3RT2027-□BB40	3RT2027-□AP00	3RT2027-□N□30
38	3RT2028-□BB40	3RT2028-□AP00	3RT2028-□N□30

Overload relays	
Setting range [A]	Article No. thermal overload relay CLASS 10
11 – 16	3RU2126-4A□0
14 – 20	3RU2126-4B□0
17 – 22	3RU2126-4C□0
20 – 25	3RU2126-4D□0
23 – 28	3RU2126-4N□0
27 – 32	3RU2126-4E□0
30 – 36	3RU2126-4P□0
34 – 40	3RU2126-4F□0

Setting range [A]	Article No. electronic overload relay CLASS 10E
6 – 25	3RB3026-1Q□0
10 – 40	3RB3026-1V□0

Screw terminals: ①  
Spring-loaded terminals<sup>2)</sup>: ②

Screw terminals: ① 21 – 28 V AC/DC: ②  
Spring-loaded terminals: ② 95 – 130 V AC/DC: ③  
200 – 280 V AC/DC: ④

Screw terminals: ②  
Spring-loaded terminals: ③

Screw terminals: ②  
Spring-loaded terminals: ③

## Starter combinations size S0: Motor starter protector for motor protection, contactor and current monitoring relay

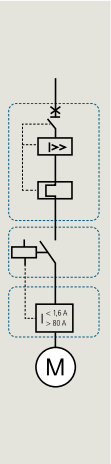

Standard three-phase motor 4-pole at 400 V AC	
[kW]	[A]
7.5	15.5
7.5	15.5
11	22
11	22
15	29
15	29
18.5	35
18.5	35

MSPs for motor protection	
Setting range for thermal overload release CLASS 10 [A]	Article No.
10 – 16	3RV2021-4AA□0
13 – 20	3RV2021-4BA□0
16 – 22	3RV2021-4CA□0
18 – 25	3RV2021-4DA□0
23 – 28	3RV2021-4NA□0
27 – 32	3RV2021-4EA□0
30 – 36	3RV2021-4PA10
34 – 40	3RV2021-4FA10

Contactors (auxiliary contacts 1NO or 1NC integrated)			
Rated operational current [A]	Article No.		
	Control supply voltage		
	24 V DC	230 V AC, 50 Hz	50/60 Hz AC/DC
17	3RT2025-□BB40	3RT2025-□AP00	3RT2025-□N□30
25	3RT2026-□BB40	3RT2026-□AP00	3RT2026-□N□30
32	3RT2027-□BB40	3RT2027-□AP00	3RT2027-□N□30
38	3RT2028-□BB40	3RT2028-□AP00	3RT2028-□N□30

Current monitoring relays		
Meas. range [A]	Article No. Basic (analog adjustable)	Article No. Standard (digital adjustable)*
4 – 40	3RR2142-□A□30	3RR2242-□F□30

Screw terminals: ①  
Spring-loaded terminals<sup>2)</sup>: ②

Screw terminals: ① 21 – 28 V AC/DC: ②  
Spring-loaded terminals: ② 95 – 130 V AC/DC: ③  
200 – 280 V AC/DC: ④

Screw terminals: ①  
Spring-loaded terminals: ②  
24 V AC/DC: ③  
24 – 240 V AC/DC: ④

<sup>2)</sup> Up to 32 A

\*likewise available as 3RR24 with IO-Link

## Fuseless assembly

### Assembly up to 18.5 kW (S0)

Motor starter protector for motor protection, 3RW30 soft starter with current monitoring relay (stand-alone installation)

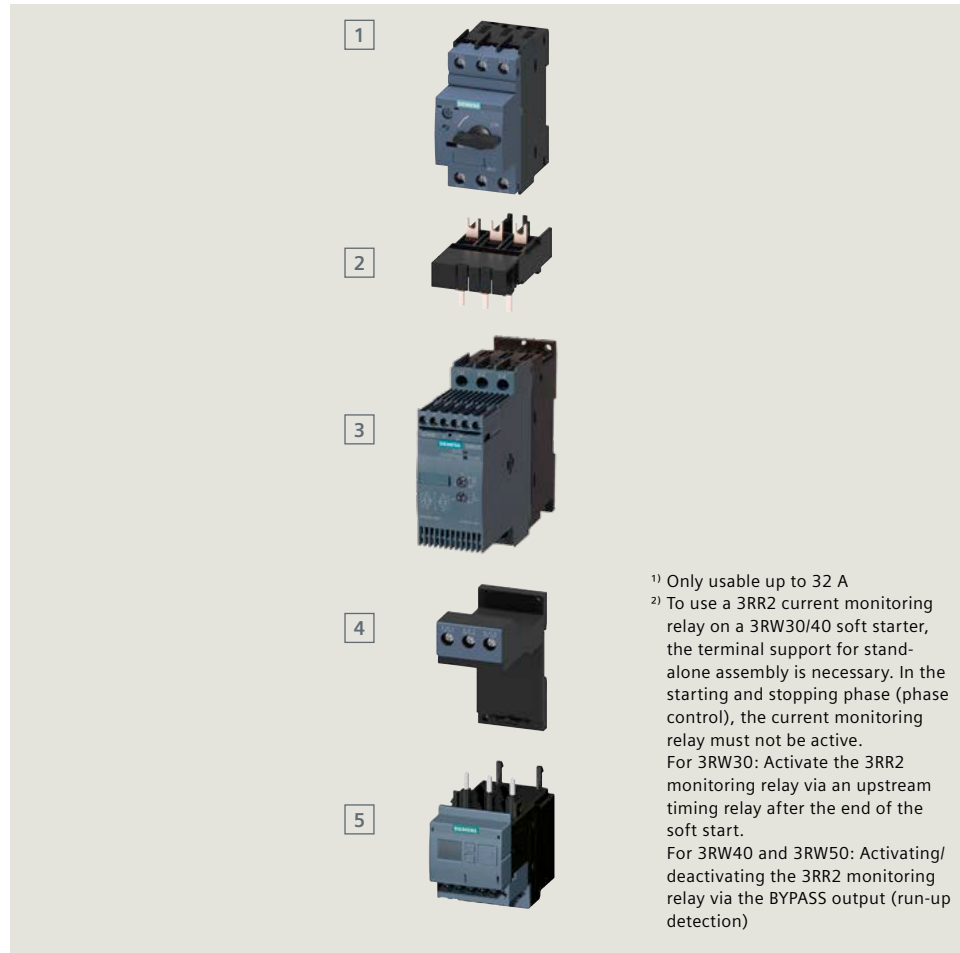

Type	Screw terminals	Spring-loaded terminals
1 Motor starter protector	3RV2021-□□□□1□	3RV2021-□□□□2□
2 Link module <sup>1)</sup>	3RA2921-1BA00	3RA2921-2GA00
3 Soft starter	3RW302□-1□□□□	3RW302□-2□□□□
4 Terminal support stand-alone	3RU2926-3AA01	3RU2926-3AC01
5 Current monitoring relay <sup>2)</sup>	3RR2□42-1□□□□	3RR2□42-2□□□□

Motor starter protectors for motor protection, 3RW40 soft starter (integrated electronic overload relay)



Type	Screw terminals	Spring-loaded terminals
1 Motor starter protector	3RV2021-□□□□1□	3RV2021-□□□□2□
2 Link module <sup>1)</sup>	3RA2921-1BA00	3RA2921-2GA00
3 Soft starter	3RW402□-1□□□□	3RW402□-2□□□□

# Starter combinations in size S0: Motor starter protector for motor protection, 3RW30 soft starter and current monitoring relay

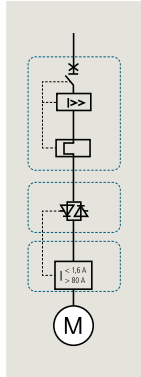

Standard three-phase motor 4-pole at 400 V

[kW]	[A]
11	22
11	22
15	29
15	29
18.5	35
18.5	35

<sup>1)</sup> Rated operational voltage 200 – 480 V



**MSPs for motor protection**

Setting range for thermal overload release CLASS 10

[A]	Article No.
16 – 22	3RV2021-4CA □0
18 – 25	3RV2021-4DA □0
23 – 28	3RV2021-4NA □0
27 – 32	3RV2021-4EA □0
30 – 36	3RV2021-4PA10
34 – 40	3RV2021-4FA10



Screw terminals: 1  
Spring-loaded terminals up to 32 A: 2



**Soft starters<sup>1)</sup> without overload protection**

Rated operational current [A]	Article No.	
	Control supply voltage	
	24 V AC/DC	110 – 230 V AC/DC
25	3RW3026-□BB04	3RW3026-□BB14
32	3RW3027-□BB04	3RW3027-□BB14
38	3RW3028-□BB04	3RW3028-□BB14

Screw terminals: 1  
Spring-loaded terminals: 2





**Current monitoring relays**

Meas. range [A]	Article No.	
	Basic (analog adjustable)	Standard (digital adjustable)*
4 – 40	3RR2142-□A□30	3RR2242-□F□30

Screw terminals: 1      24 V AC/DC: A  
Spring-loaded terminals: 2    24 – 240 V AC/DC: W

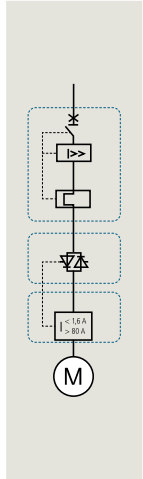
\*likewise available as 3RR24 with IO-Link



Standard three-phase motor 4-pole at 400 V AC

[kW]	[A]
5.5	11.5
7.5	15.5
7.5	15.5
11	22
11	22
15	29
15	29
18.5	35
18.5	35



**MSPs for motor protection**

Setting range for thermal overload release CLASS 10

[A]	Article No.
9 – 12.5	3RV2021-1KA □0
10 – 16	3RV2021-4AA □0
13 – 20	3RV2021-4BA □0
16 – 22	3RV2021-4CA □0
18 – 25	3RV2021-4DA □0
23 – 28	3RV2021-4NA □0
27 – 32	3RV2021-4EA □0
30 – 36	3RV2021-4PA10
34 – 40	3RV2021-4FA10

Screw terminals: 1  
Spring-loaded terminals up to 32 A 2



**Soft starters<sup>1)</sup> with overload protection**

Rated operational current [A]	Article No.	
	Control supply voltage	
	24 V AC/DC	110 – 230 V AC/DC
12.5	3RW4024-□BB04	3RW4024-□BB14
25	3RW4026-□BB04	3RW4026-□BB14
32	3RW4027-□BB04	3RW4027-□BB14
38	3RW4028-□BB04	3RW4028-□BB14

Screw terminals: 1  
Spring-loaded terminals: 2

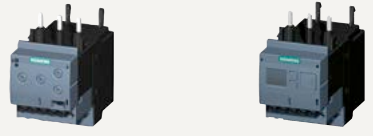

**Current monitoring relays**

Meas. range [A]	Article No.	
	Basic (analog adjustable)	Standard (digital adjustable)
4 – 40	3RR2142-□A□30	3RR2242-□F□30

Screw terminals: 1      24 V AC/DC: A  
Spring-loaded terminals: 2      24 – 240 V AC/DC: W

<sup>1)</sup> Rated operational voltage 200 – 480 V



## Fuseless assembly

### Size S2 up to 37 kW

Motor starter protector for starter protection, contactor and overload relay

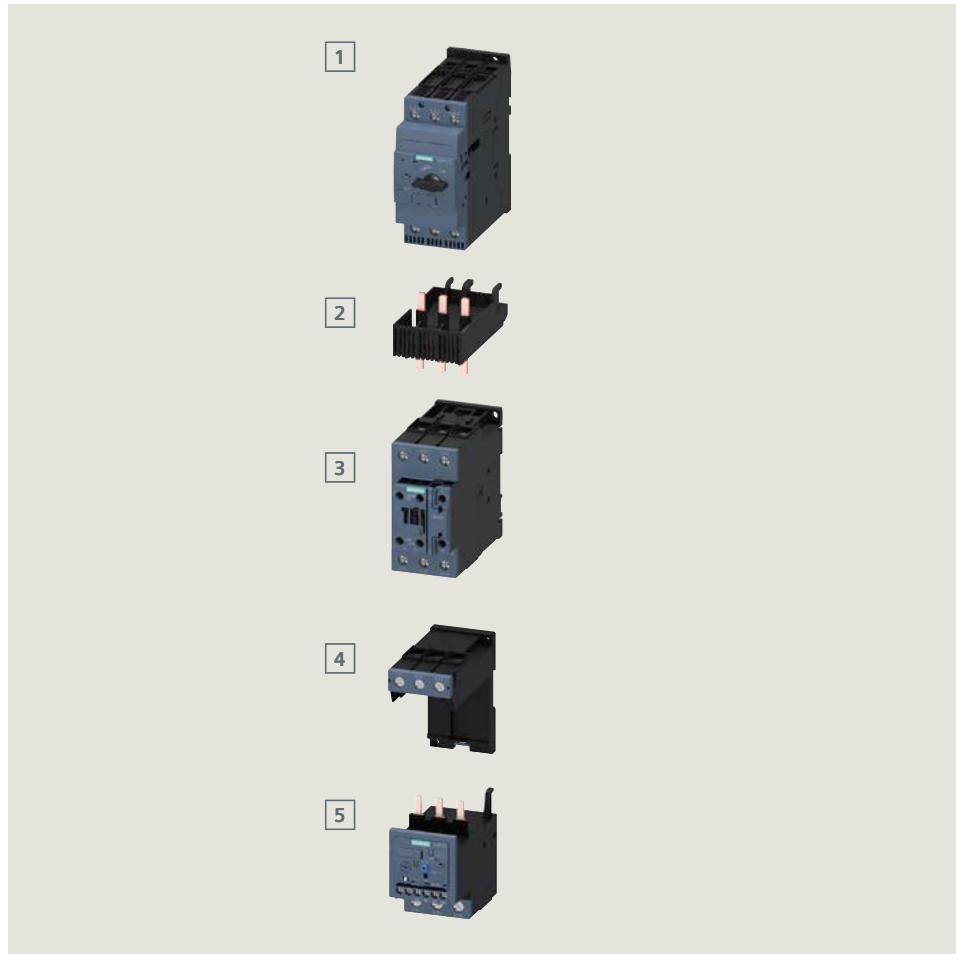

Type	Article number
1 Motor starter protector	3RV233□-□□□1□
2 Link module (can only be used up to 65 A)	3RA2931-1AA00
3 Contactor	3RT203□-□□□□□
4 Terminal support for stand-alone installation	3RU2936-3AA01
5 Overload relay	3RU2136-□□B0 or 3RB3□3□-□□B0

Motor starter protector for motor protection, contactor with current monitoring relay

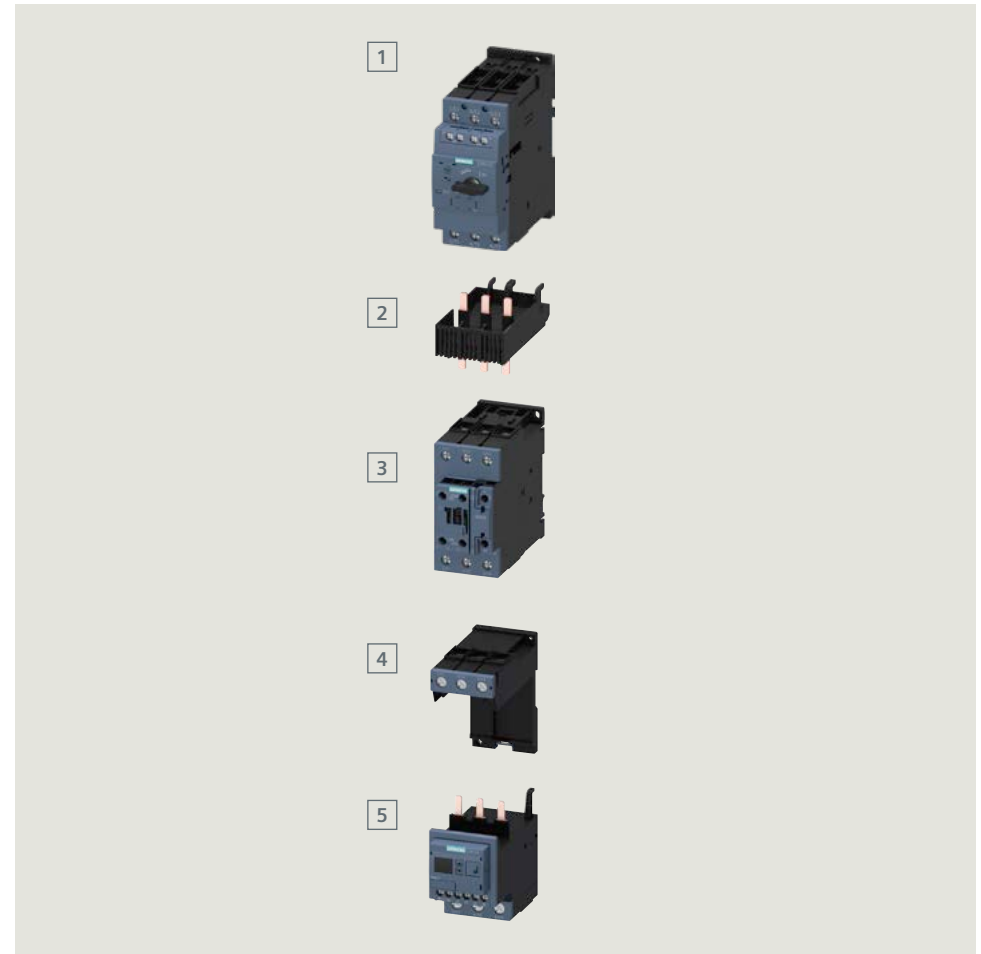

Type	Article number
1 Motor starter protector	3RV203□-□□□1□
2 Link module (can only be used up to 65 A)	3RA2931-1AA00
3 Contactor	3RT203□-□□□□□
4 Terminal support for stand-alone installation	3RU2936-3AA01
5 Current monitoring relay	3RR2□43-1□□□□

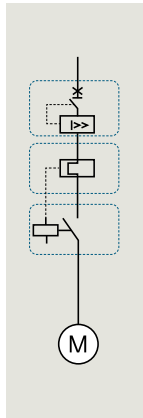

Standard three-phase motor 4-pole at 400 V AC	
[kW]	[A]
18.5	35
22	41
30	55
37	66



MSPs for starter protection	
Rated breaker current [A]	Article No.
36	3RV233-4PC10
40	3RV233-4UC10
45	3RV233-4VC10
52	3RV233-4WC10
59	3RV233-4XC10
65	3RV233-4JC10
73	3RV233-4KC10
80 <sup>2)</sup>	3RV233-4RC10

Standard switching capacity 65 kA at 400 V:    
 Increased switching capacity 100 kA at 400 V:



Contactors (auxiliary contacts 1NO or 1NC integrated)		
Rated operational current [A]	Article No.	Article No.
	230 V AC, 50 Hz	50/60 Hz AC/DC
40	3RT2035-AP00	3RT2035-N30
50	3RT2036-AP00	3RT2036-N30
65	3RT2037-AP00	3RT2037-N30
80	3RT2038-AP00	3RT2038-N30

Screw terminals:  20 – 33 V AC/DC:    
 Spring-loaded terminals in auxiliary circuit:  83 – 155 V AC/DC:    
 175 – 280 V AC/DC:



Overload relays	
Setting range [A]	Article No. thermal overload relay, CLASS 10
22 – 32	3RU2136-4EB0
28 – 40	3RU2136-4FB0
36 – 45	3RU2136-4GB0
40 – 50	3RU2136-4HB0
47 – 57	3RU2136-4QB0
54 – 65	3RU2136-4JB0
62 – 73	3RU2136-4KB0
70 – 80	3RU2136-4RB0



Setting range [A]	Article No. electronic overload relay CLASS 10E <sup>1)</sup>
20 – 80	3RB3036-1W

Contactor mounting:     
 Straight-thr. transf.:

<sup>1)</sup> As 3RB3133 also available with another CLASS and other functions

## Starter combinations in size S2: Motor starter protector for motor protection, contactor with current monitoring relay

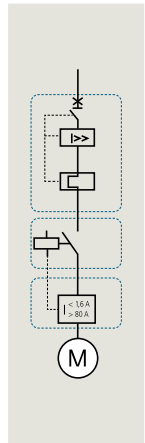

Standard three-phase motor 4-pole at 400 V AC	
[kW]	[A]
18.5	35
22	41
30	55
37	66





MSPs for motor protection	
Setting range for thermal overload release CLASS 10	
[A]	Article No.
28 – 36	3RV203-4PA10
32 – 40	3RV203-4UA10
35 – 45	3RV203-4VA10
42 – 52	3RV203-4WA10
49 – 59	3RV203-4XA10
54 – 65	3RV203-4JA10
62 – 73	3RV203-4KA10
70 – 80 <sup>2)</sup>	3RV203-4RA10

Standard switching capacity 65 kA at 400 V:  1  
Increased switching capacity 100 kA at 400 V:  2



Contactors (auxiliary contacts 1NO or 1NC integrated)		
Rated operational current	Article No.	Article No.
[A]	230 V AC, 50 Hz	50/60 Hz AC/DC
40	3RT2035-AP00	3RT2035-N30
50	3RT2036-AP00	3RT2036-N30
65	3RT2037-AP00	3RT2037-N30
80	3RT2038-AP00	3RT2038-N30

Screw terminals:  1 20 – 33 V AC/DC:  B  
Spring-loaded terminals in auxiliary circuit:  3 83 – 155 V AC/DC:  F  
175 – 280 V AC/DC:  P

Current monitoring relays		
Meas. range	Article No. Basic (analog adjustable)	Article No. Standard (digital adjustable)*
[A]		
8 – 80	3RR2143-A30	3RR2243-F30

Screw terminals:  1 24 V AC/DC:  A  
Spring-loaded terminals in auxiliary circuit:  3 24 – 240 V AC/DC:  W

\*likewise available as 3RR24 with IO-Link

<sup>2)</sup> Suitable for use with IE3 motors up to a starting current of 720 A. For higher starting currents we recommend using 3RV1 motor starter protectors size S3.

## Fuseless assembly

### Size S2 up to 37 kW

Motor starter protector for motor protection, 3RW30 soft starter without overload protection and current monitoring relay (stand-alone installation)

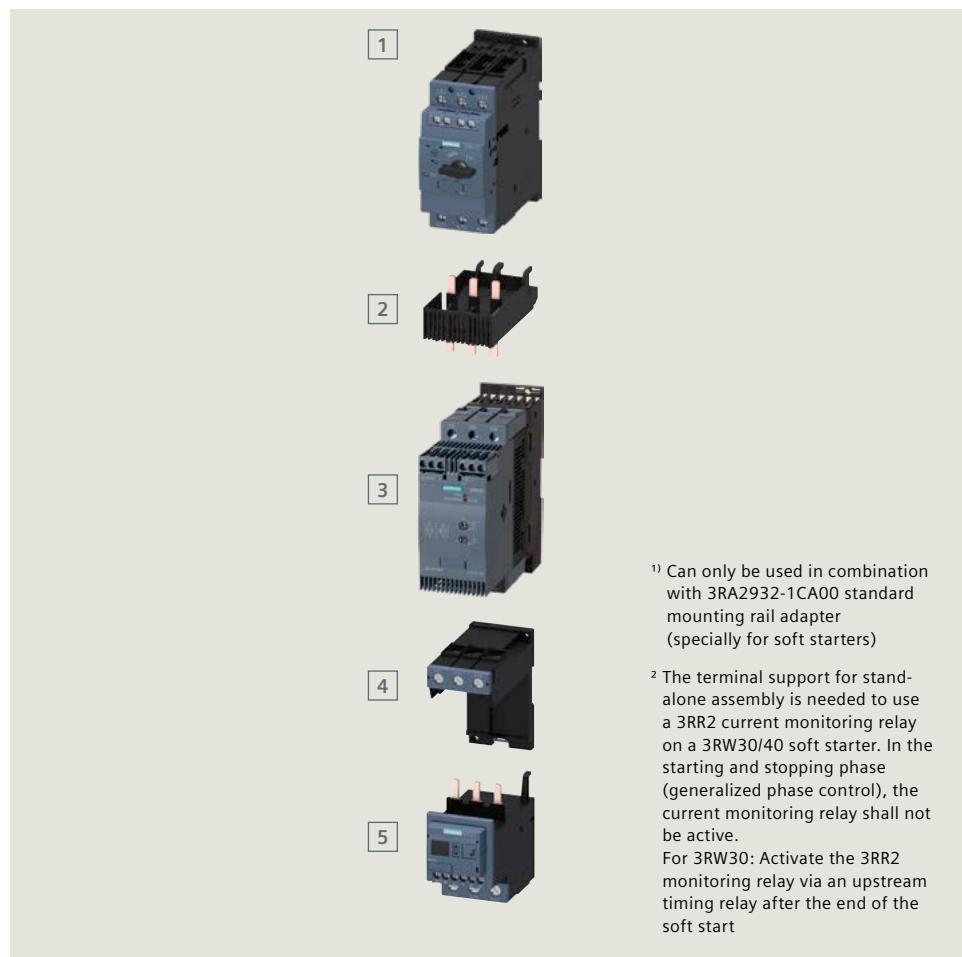

Type	Screw terminals
1 Motor starter protector	3RV203□-□□□1□
2 Link module (can only be used up to 65 A) <sup>1)</sup>	3RA2931-1AA00
3 Soft starter	3RW303□-1□□□□
4 Terminal support for stand-alone installation	3RU2936-3AA01
5 Current monitoring relay <sup>2)</sup>	3RR2□43-3□□□□

Motor starter protector for motor protection, 3RW40 soft starter with overload protection and current monitoring relay (stand-alone installation)

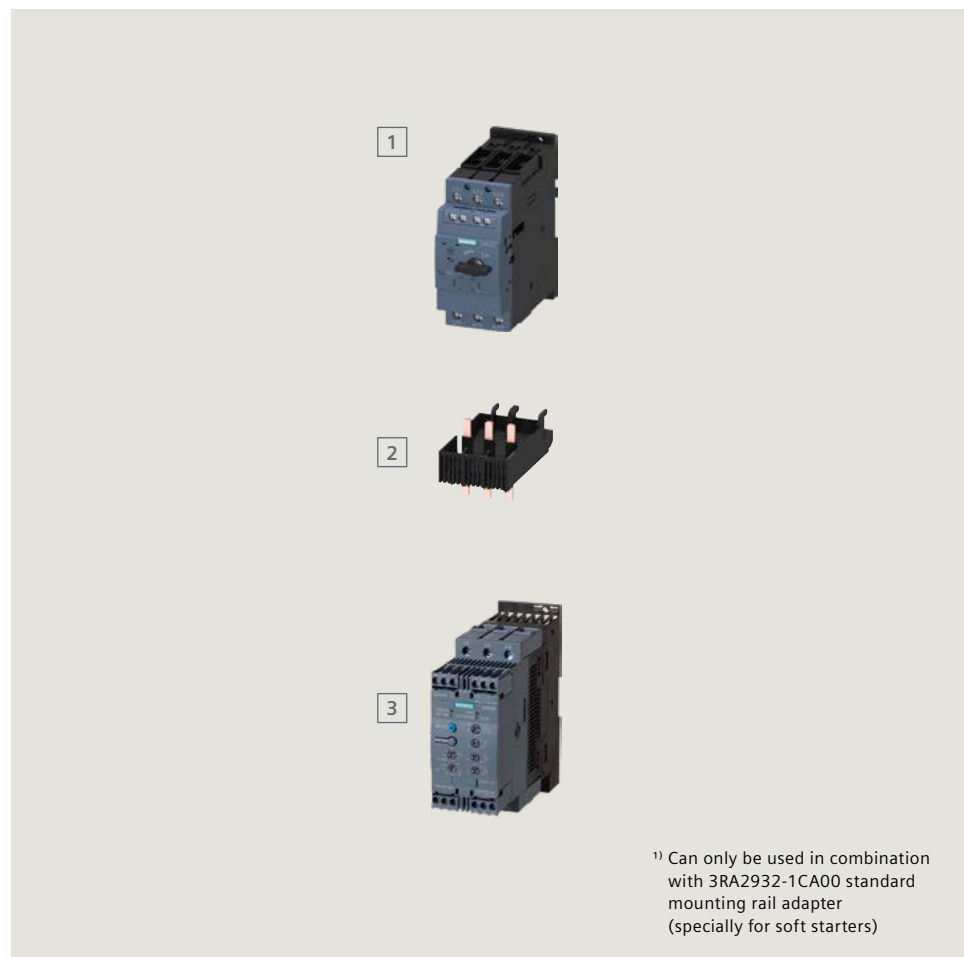

Type	Screw terminals
1 Motor starter protector	3RV203□-□□□1□
2 Link module (can only be used up to 65 A) <sup>1)</sup>	3RA2931-1AA00
3 Soft starter	3RW403□-1□□□□

## Starter combinations in size S2: Motor starter protector for motor protection, 3RW30 soft starter without overload protection but with current monitoring relay

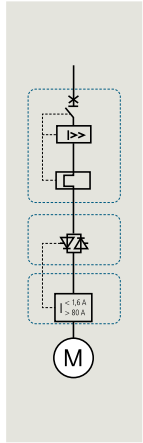

Standard three-phase motor 4-pole at 400 V AC

[kW]	[A]
18.5	35
22	41
30	55
37	66





**MSPs for motor protection**  
Setting range for thermal overload release CLASS 10

[A]	Article No.
28 – 36	3RV203-4PA10
32 – 40	3RV203-4UA10
35 – 45	3RV203-4VA10
42 – 52	3RV203-4WA10
49 – 59	3RV203-4XA10
54 – 65	3RV203-4JA10
62 – 73	3RV203-4KA10
70 – 80	3RV203-4RA10



**Soft starter without overload prot.**

Rated operational current [A]	Article No.
45	3RW3036-1BB-4
63	3RW3037-1BB-4
72	3RW3038-1BB-4

**Current monitoring relays**

Meas. range [A]	Article No. Basic (analog adjustable)	Article No. Standard (digital adjustable)
8 – 80	3RR2143-□A□30	3RR2243-□F□30

Standard switching capacity 65 kA at 400 V: 1  
Increased switching capacity 100 kA at 400 V: 2

24 V AC/DC: 0  
110 – 230 V AC/DC: 1

Screw terminals: 1      24 V AC/DC: A  
Spring-loaded terminals in auxiliary circuit: 3      110 – 230 V AC/DC: W

# Starter combinations in size S2: Motor starter protector for motor protection, 3RW40 soft starter with overload protection and current monitoring relay

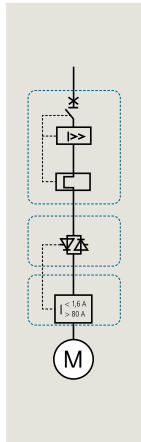

Standard three-phase motor 4-pole at 400 V

[kW]	[A]
18.5	35
22	41
30	55
37	66

  
MSPs for motor protection

Setting range for thermal overload release CLASS 10

[A]	Article No.
28 – 36	3RV203-4PA10
32 – 40	3RV203-4UA10
35 – 45	3RV203-4VA10
42 – 52	3RV203-4WA10
49 – 59	3RV203-4XA10
54 – 65	3RV203-4JA10
62 – 73	3RV203-4KA10
70 – 80	3RV203-4RA10

  
Soft starter with overload prot.

Rated operational current [A]	Article No.
45	3RW4036-1BB-4
63	3RW4037-1BB-4
72	3RW4038-1BB-4

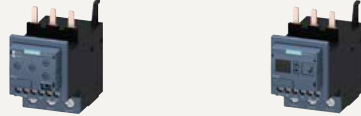
  
Current monitoring relays

Meas. range [A]	Article No. Basic (analog adjustable)	Article No. Standard (digital adjustable)*
8 – 80	3RR2143-□A□30	3RR2243-□F□30

Standard switching capacity 65 kA at 400 V: ①  
Increased switching capacity 100 kA at 400 V: ②

24 V AC/DC: ①  
110 – 230 V AC/DC: ②

Screw terminals: ① 24 V AC/DC: ②  
Spring-loaded terminals in auxiliary circuit: ③ 110 – 230 V AC/DC: ④

\*likewise available as 3RR24 with IO-Link



## Fuseless assembly

### Size S3 up to 55 kW

Motor starter protector for starter protection, contactor with overload relay

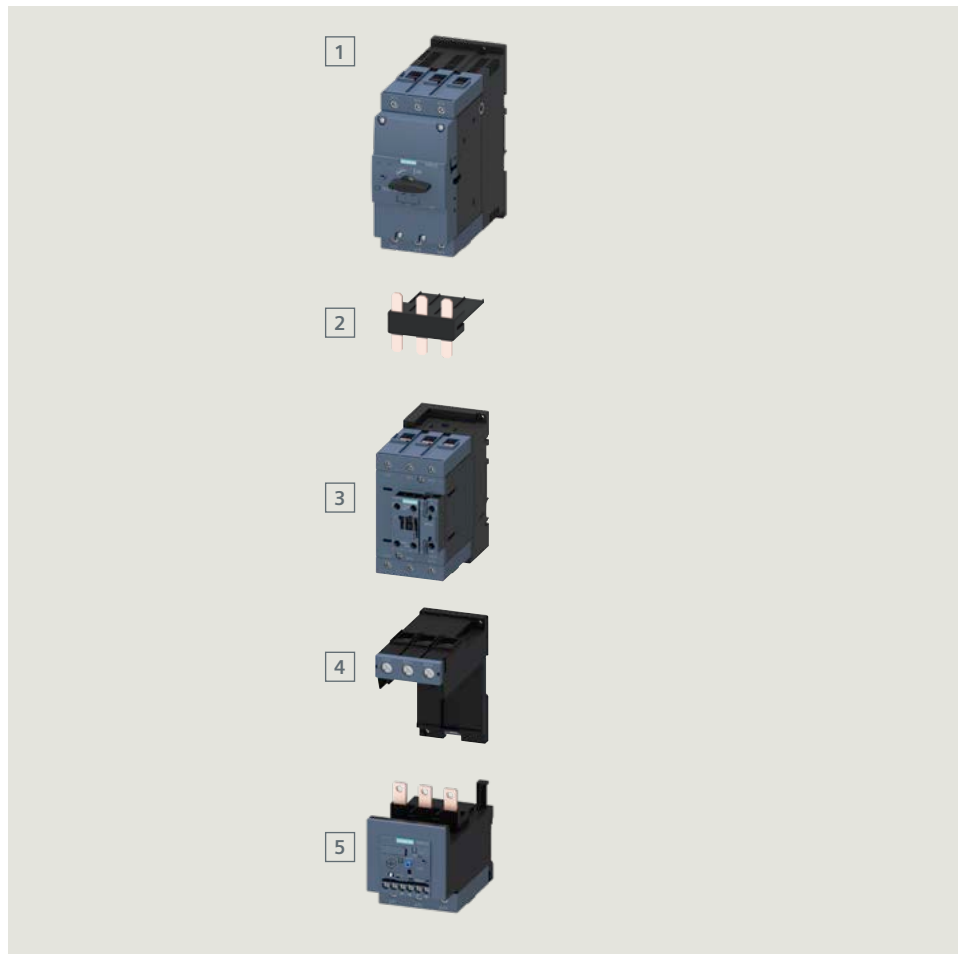

Type	Screw terminals
1 Motor starter protector	3RV234-□-□□□1□
2 Link module <sup>1)</sup>	3RA1941-1AA00
3 Contactor	3RT204-□-□□□□□
4 Terminal support for stand-alone installation	3RU2946-3AA01
5 Overload relay	3RU2146-□□B0 or 3RB3□4□-□□B0

<sup>1)</sup> Installation with link module only allowable on standard mounting rail adapter.

Motor starter protectors for motor protection, contactor and overload relay

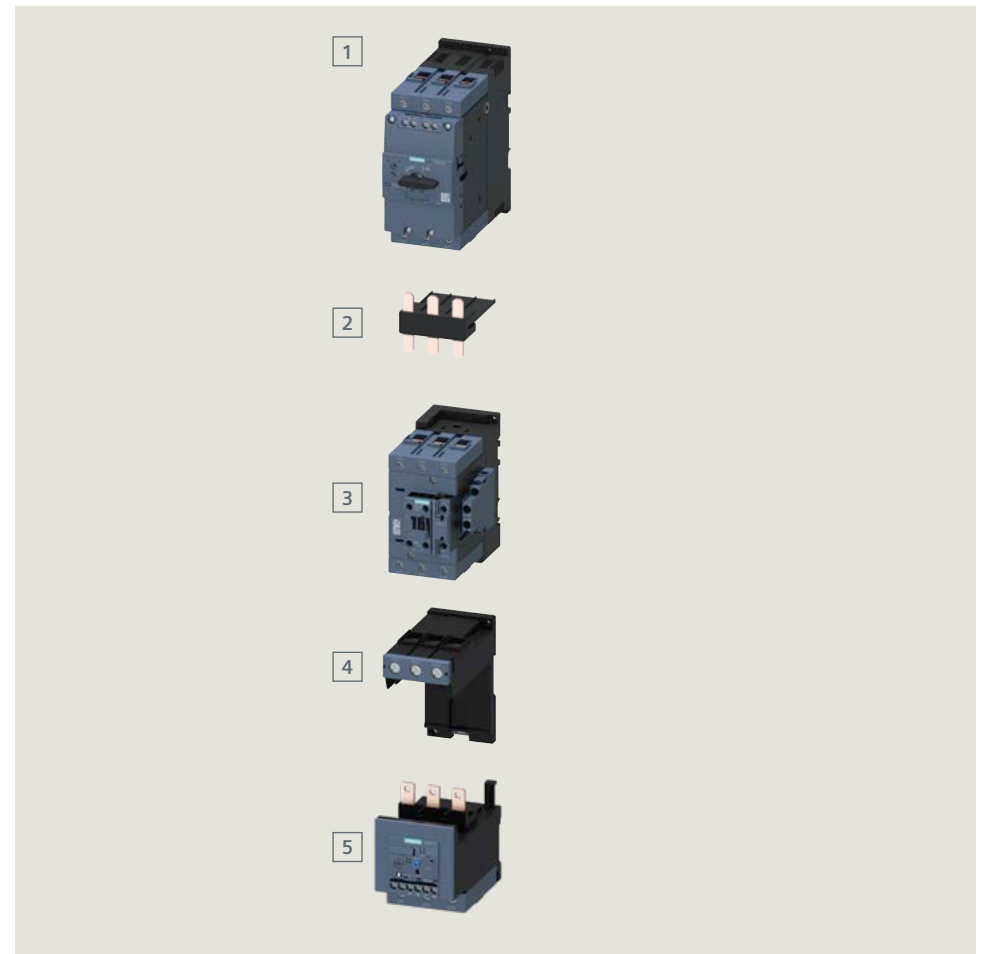

Type	Screw terminals
1 Motor starter protector	3RV204-□-□□□1□
2 Link module <sup>1)</sup>	3RA1941-1AA00
3 Contactor	3RT204-□-□□□□□
4 Terminal support for stand-alone installation	3RU2946-3AA01
5 Overload relay	3RU2146-□□B0 or 3RB3□4□-□□B0

<sup>1)</sup> Installation with link module only allowable on standard mounting rail adapter.

## Starter combinations in size S3: Motor starter protector for motor protection and contactor

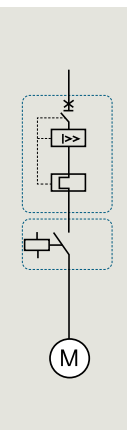

Standard three-phase motor 4-pole at 400 V AC	
[kW]	[A]
37	66
45	80
55	97



**Motor starter protector**

Setting range for thermal overload release CLASS 10

[A]	Article No.
36 – 50	3RV204-4HA10
45 – 63	3RV204-4JA10
57 – 75	3RV204-4KA10
65 – 84	3RV204-4RA10
75 – 93	3RV204-4YA10
80 – 100	3RV204-4MA10

3 VA



**Contactors**

Rated operational current [A]	Article No. 230 V AC, 50 Hz	Article No. 50/60 Hz AC/DC
80	3RT2045-AP00	3RT2045-N30
95	3RT2046-AP00	3RT2046-N30
110	3RT2047-AP00	3RT2047-N30

Standard switching capacity 65 kA at 400 V:

Increased switching capacity 100 kA at 400 V:

Screw terminals:  20 – 33 V AC/DC:

Spring-loaded terminals in auxiliary circuit:  83 – 155 V AC/DC:

175 – 280 V AC/DC:

## Starter combinations in size S3: Motor starter protector for starter protection, contactor with overload relay

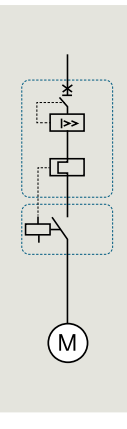

Standard three-phase motor 4-pole at 400 V AC	
[kW]	[A]
37	66
45	80
55	97

**Motor starter protector**

MSP rated current [A]	Article No.
50	3RV234-4HC10
63	3RV234-4JC10
75	3RV234-4KC10
84	3RV234-4RC10
93	3RV234-4YC10
100	3RV234-4MC10

3 VA

**Contactors**

Rated operational current [A]	Article No. 230 V AC, 50 Hz	Article No. 50/60 Hz AC/DC
80	3RT2045-AP00	3RT2045-N30
95	3RT2046-AP00	3RT2046-N30
110	3RT2047-AP00	3RT2047-N30

**Overload relay**

Setting range CLASS 10 [A]	Article No. thermal overload relay	Setting range CLASS 10E [A]	Article No. electrical overload relay
36 – 50	3RU2146-4HB0	32 – 115	3RB3046-1X□□
45 – 63	3RU2146-4JB0		
57 – 75	3RU2146-4KB0		
70 – 90	3RU2146-4LB0		
80 – 100	3RU2146-4MB0		

Standard switching capacity 65 kA at 400 V:

Increased switching capacity 100 kA at 400 V:

Screw terminals:  20 – 33 V AC/DC:

Spring-loaded terminals in auxiliary circuit:  83 – 155 V AC/DC:

175 – 280 V AC/DC:

Screw terminals in auxiliary circuit:

Spring-loaded terminals in auxiliary circuit:

Straight-through transformer, screw terminals in auxiliary circuit:

Straight-through transformer, spring-loaded terminals in auxiliary circuit:

For mounting onto contactor main circuit:

Stand-alone installation:

## Fuseless assembly

### Size S3 up to 55 kW

Motor starter protector for motor protection, 3RW30 soft starter without overload protection

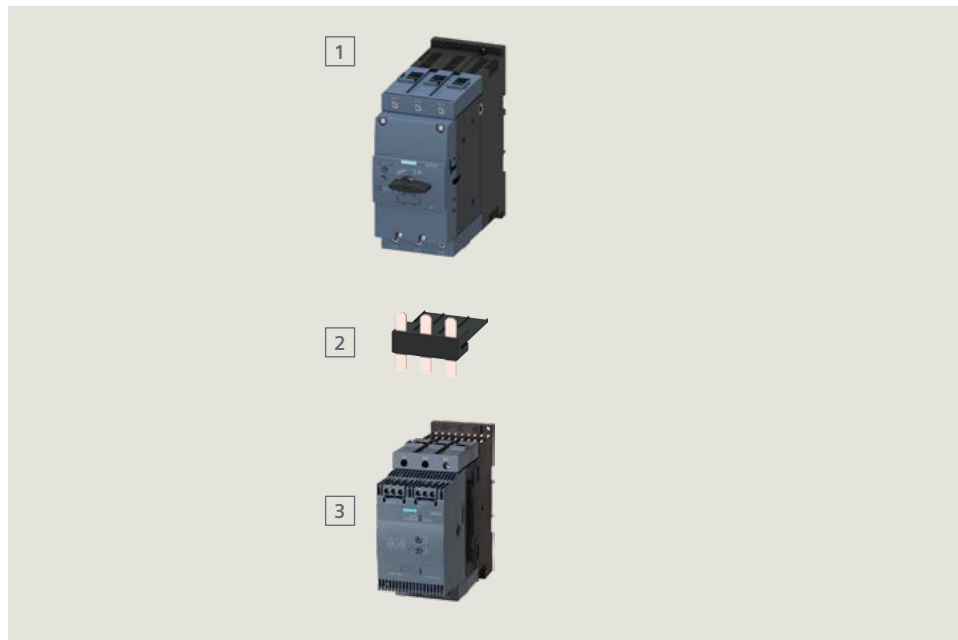

Type	Screw terminals
1 Motor starter protector	3RV204□-□□□1□
2 Link module <sup>1)</sup>	3RA1941-1AA00
3 Soft starter	3RW304□-1□□□□

<sup>1)</sup> Installation with link module only allowable on mounting plate.

Motor starter protector for motor protection, 3RW40 soft starter with overload protection

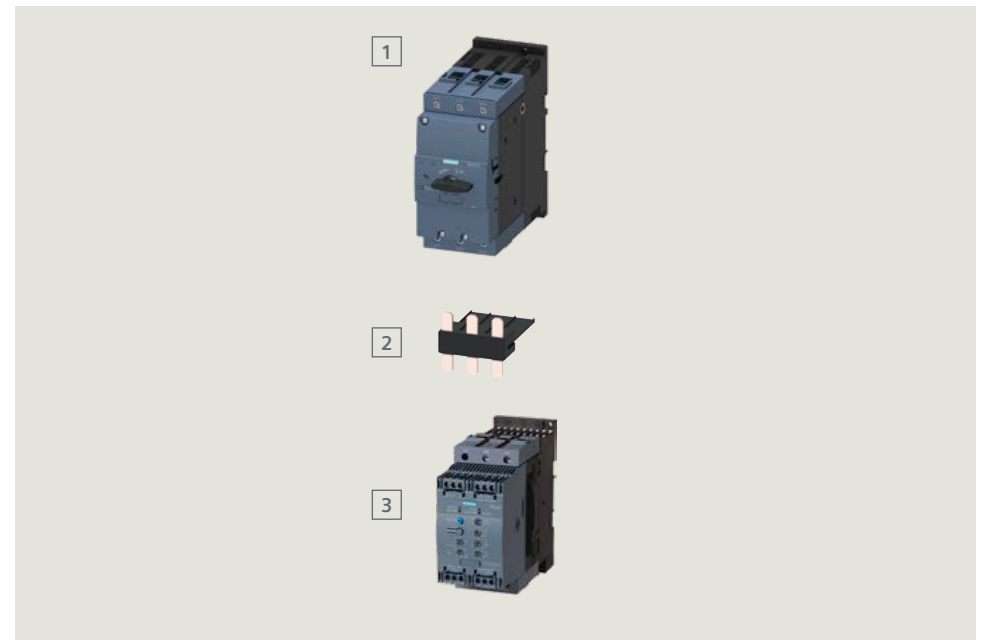

Type	Screw terminals
1 Motor starter protector	3RV204□-□□□1□
2 Link module <sup>1)</sup>	3RA1941-1AA00
3 Soft starter	3RW404□-1□□□□

## Starter combinations in size S3: Motor starter protector for motor protection and 3RW30 soft starter without overload protection

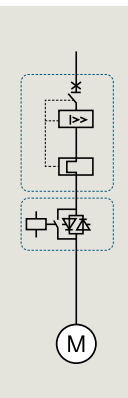

Standard three-phase motor 4-pole at 400 V AC	
[kW]	[A]
37	66
45	80
55	97

Motor starter protector	
Setting range for thermal overload release CLASS 10	
[A]	Article No.
36 – 50	3RV204□-4HA10
45 – 63	3RV204□-4JA10
57 – 75	3RV204□-4KA10
65 – 84	3RV204□-4RA10
75 – 93	3RV204□-4YA10
80 – 100	3RV204□-4MA10
3 VA	

Soft starter	
Rated operational current [A]	Article No.
80	3RW3046-1BB□4
106	3RW3047-1BB□4

Standard switching capacity 65 kA at 400 V:

Increased switching capacity 100 kA at 400V:

24 V AC/DC:

110 – 230 V AC/DC:

## Starter combinations in size S3: Motor starter protector for motor protection and 3RW40 soft starter with overload protection

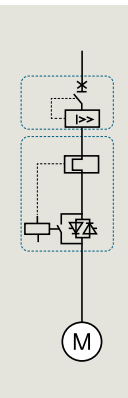

Standard three-phase motor 4-pole at 400 V AC	
[kW]	[A]
37	66
45	80
55	97

Motor starter protector	
Setting range for thermal overload release CLASS 10	
[A]	Article No.
36 – 50	3RV204□-4HA10
45 – 63	3RV204□-4JA10
57 – 75	3RV204□-4KA10
65 – 84	3RV204□-4RA10
75 – 93	3RV204□-4YA10
80 – 100	3RV204□-4MA10
3 VA	

Soft starter	
Rated operational current [A]	Article No.
80	3RW4046-1BB□4
106	3RW4047-1BB□4

Standard switching capacity 65 kA at 400 V:

Increased switching capacity 100 kA at 400 V:

24 V AC/DC:

110 – 230 V AC/DC:

# Selection and ordering data for fused feeders of sizes S6, S10, S12

## Size S6



Standard three-phase motor 4-pole at 400 V AC		Contactors				
		Rated operational current [A]	Solenoid-operated mechanism	Control supply voltage [V AC/DC]	Article No. contactors	Article No. vacuum contactors
55	97	115	<b>Conventional</b>	220 – 240	<b>3RT1054-1AP36</b>	–
			<b>Electronic</b> – for 24 V DC PLC output – for 24 V DC PLC output, w. RLT <sup>1)</sup>	200 – 277 200 – 277	<b>3RT1054-1NP36</b> <b>3RT1054-1PP35</b>	– –
75	132	150	<b>Conventional</b>	220 – 240	<b>3RT1055-6AP36</b>	–
			<b>Electronic</b> – for 24 V DC PLC output – for 24 V DC PLC output, w. RLT <sup>1)</sup>	200 – 277 200 – 277	<b>3RT1055-6NP36</b> <b>3RT1055-6PP35</b>	– –
90	160	185	<b>Conventional</b>	220 – 240	<b>3RT1056-6AP36</b>	–
			<b>Electronic</b> – for 24 V DC PLC output – for 24 V DC PLC output, w. RLT <sup>1)</sup>	200 – 277 200 – 277	<b>3RT1056-6NP36</b> <b>3RT1056-6PP35</b>	– –

<sup>1)</sup> RLT: remaining lifetime

<sup>2)</sup> As 3RB2143 also available with another CLASS and other functions



Overload relays		
Setting range [A]	Article No. electronic overload relay CLASS 10	Version
50 – 200	<b>3RB2056-1FW2<sup>2)</sup></b>	w. str.-through transf.
50 – 200	<b>3RB2056-1FC2<sup>2)</sup></b>	w. busbar connection



Soft starter			
Operating power at 400 V [kW]	Operating current at 40 °C [A]	Frame Size	Article No.
75	143	S6	<b>3RW5055-□□B□□</b>
90	171	S6	<b>3RW5056-□□B□□</b>

- Spring-type terminal
- Screw-type terminal
- Analog output
- Thermistor motor protection
- 24 V AC/DC
- 110–250 V AC
- 200–480 V
- 200–600 V

## Size S10



Standard three-phase motor 4-pole at 400 V AC		Contactors					Overload relays			Soft starter			
		Rated operational current [A]	Solenoid-operated mechanism	Control supply voltage [V AC/DC]	Article No. contactors	Article No. vacuum contactors	Setting range [A]	Article No. electronic overload relay CLASS 10	Version	Operating power at 400 V [kW]	Operating current at 40 °C [A]	Frame Size	Article No.
110	195	225	Conventional	220 – 240	3RT1064-6AP36	3RT1264-6AP36	55 – 250	3RB2066-1GC2 <sup>2)</sup>	with busbar connection	110	210	S12	3RW5072-□□B□□
			Electronic – for 24 V DC PLC output – for 24 V DC PLC output, w. RLT <sup>1)</sup>	200 – 277 200 – 277	3RT1064-6NP36 3RT1064-6PP35	3RT1264-6NP36 –							
132	230	265	Conventional	220 – 240	3RT1065-6AP36	3RT1265-6AP36	160 – 630	3RB2066-1MC2 <sup>2)</sup>	with busbar connection				
			Electronic – for 24 V DC PLC output – for 24 V DC PLC output, w. RLT <sup>1)</sup>	200 – 277 200 – 277	3RT1065-6NP36 3RT1065-6PP35	3RT1265-6NP36 –							
160	280	300	Conventional	220 – 240	3RT1066-6AP36	3RT1266-6AP36	160 – 630	3RB2066-1MC2 <sup>2)</sup>	with busbar connection	160	315	S12	3RW5074-□□B□□
			Electronic – for 24 V DC PLC output – for 24 V DC PLC output, w. RLT <sup>1)</sup>	200 – 277 200 – 277	3RT1066-6NP36 3RT1066-6PP35	3RT1266-6NP36 –							

<sup>1)</sup> RLT: remaining lifetime signal

<sup>2)</sup> As 3RB2163 also available with another CLASS and further functions

▲▲▲▲▲  
 Spring-type terminal  2  
 Screw-type terminal  6  
 Analog output  A  
 Thermistor motor protection  T  
 24 V AC/DC  0  
 110–250 V AC  1  
 200–480 V  4  
 200–600 V  5

\* Frame Size S12



# Selection and ordering data for fused feeders of sizes S6, S10, S12

## Size S12



### Contactors

Standard three-phase motor 4-pole at 400 V AC		Rated operational current [A]	Solenoid-operated mechanism		Control supply voltage [V AC/DC]	Article No. contactors	Article No. vacuum contactors
			Conventional	Electronic			
200	350	400	Conventional		220 – 240	3RT1075-6AP36	3RT1275-6AP36
			Electronic	– for 24 V DC PLC output – for 24 V DC PLC output, w. RLT <sup>2)</sup>	200 – 277 200 – 277	3RT1075-6NP36 3RT1075-6PP35	3RT1275-6NP36 –
250	430	500	Conventional		220 – 240	3RT1076-6AP36	3RT1276-6AP36
			Electronic	– for 24 V DC PLC output – for 24 V DC PLC output, w. RLT <sup>2)</sup>	200 – 277 200 – 277	3RT1076-6NP36 3RT1076-6PP35	3RT1276-6NP36 –

For applications over 100 A, SIRIUS contactors can be combined with SENTRON 3VL circuit breakers. For more detailed information, please refer to the configuration document "Configuring SIRIUS load feeders in fuseless design".

- <sup>1)</sup> When using trip CLASS 20, refer to the notes in the project planning aid "Configuring SIRIUS fuseless load feeders" and in the catalog
- <sup>2)</sup> RLT: remaining lifetime signal
- <sup>3)</sup> As 3RB2163 also available with another CLASS and further functions



### Overload relays<sup>1)</sup>

Setting range [A]	Article No. electronic overload relay CLASS 10	Version
160 – 630	3RB2066-1MC2 <sup>3)</sup>	with busbar connection



### Soft starter

Operating power at 400 V [kW]	Operating current at 40 °C [A]	Frame	
		Size	Article No.
200	370	S12	3RW5075-□□B□□
250	470	S12	3RW5076-□□B□□
315	570	S12	3RW5077-□□B□□

- Spring-type terminal
- Screw-type terminal
- Analog output
- Thermistor motor protection
- 24 V AC/DC
- 110–250 V AC
- 200–480 V
- 200–600 V

SENTRON 3VA circuit breakers are suitable for fuseless short-circuit and overload protection of soft starters from size S6. For more detailed information, please refer to the catalog.

## Fuseless load feeders up to 15 kW

Standard three-phase motor 4-pole at 400 V AC

[kW]	[A]
0.06	0.20
0.06	0.20
0.09	0.30
0.09	0.30
0.12	0.44
0.18	0.60
0.18	0.60
0.25	0.85
0.37	1.10
0.55	1.50
0.75	1.90
0.75	1.90
1.1	2.07
1.5	3.60
1.5	3.60
2.2	4.90
3	6.50
4	8.50
5.5	11.5
7.5	15.5
7.5	15.5
11	22
11	22
15	29
15	29



### 3RA21 direct-on-line starters

Setting range for thermal overload release

[A]	Type of coordination "2" at I <sub>q</sub> = 150 kA at 400 V
0.14 – 0.2	3RA2110-0B □ 15-1 □ □ □ S00
0.18 – 0.25	3RA2110-0C □ 15-1 □ □ □ S00
0.22 – 0.32	3RA2110-0D □ 15-1 □ □ □ S00
0.28 – 0.4	3RA2110-0E □ 15-1 □ □ □ S00
0.35 – 0.5	3RA2110-0F □ 15-1 □ □ □ S00
0.45 – 0.63	3RA2110-0G □ 15-1 □ □ □ S00
0.55 – 0.8	3RA2110-0H □ 15-1 □ □ □ S00
0.7 – 1	3RA2110-0J □ 15-1 □ □ □ S00
0.9 – 1.25	3RA2110-0K □ 15-1 □ □ □ S00
1.1 – 1.6	3RA2110-1A □ 15-1 □ □ □ S00
1.4 – 2	3RA2110-1B □ 15-1 □ □ □ S00
1.8 – 2.5	3RA2110-1C □ 15-1 □ □ □ S00
2.2 – 3.2	3RA2110-1D □ 15-1 □ □ □ S00
2.8 – 4	3RA2110-1E □ 15-1 □ □ □ S00

3.5 – 5	3RA2120-1F □ 24-0 □ □ □ S0
4.5 – 6.3	3RA2120-1G □ 24-0 □ □ □ S0
5.5 – 8	3RA2120-1H □ 24-0 □ □ □ S0
7 – 10	3RA2120-1J □ 24-0 □ □ □ S0
9 – 12.5	3RA2120-1K □ 24-0 □ □ □ S0
10 – 16	3RA2120-4A □ 26-0 □ □ □ S0
13 – 20	3RA2120-4B □ 27-0 □ □ □ S0
16 – 22	3RA2120-4C □ 27-0 □ □ □ S0
18 – 25	3RA2120-4D □ 27-0 □ □ □ S0
23 – 28	3RA2120-4N □ 27-0 □ □ □ S0
27 – 32	3RA2120-4E □ 27-0 □ □ □ S0

Screw terminals (standard rail mounting): **A**  
 Spring-loaded terminals (standard rail mounting): **E**  
 Screw terminals (busbar adapter): **D**  
 Spring-loaded terminals (busbar adapter): **H**  
 24 V DC: **B** **B** **4**  
 230 V AC: **A** **P** **0**



### 3RA61 compact starters

Setting range for thermal overload release

[A]	
0.1 – 0.4	3RA6120-□ A □ 3 □
0.32 – 1.25	3RA6120-□ B □ 3 □
1 – 4	3RA6120-□ C □ 3 □
3 – 12	3RA6120-□ D □ 3 □
8 – 32	3RA6120-□ E □ 3 □

Without terminals: **0** **0**  
 With screw terminals: **1** **2**  
 With spring-loaded terminals: **2** **2**  
 24 V AC/DC: **B**  
 110 – 240 V AC/DC: **P**



### SIRIUS 3RM1 motor starters

Setting range for thermal overload release

[A]	
0.1 – 0.5	3RM1 □ 01 □ AA □ 4
0.4 – 2.0	3RM1 □ 02 □ AA □ 4
1.6 – 7.0 (10 A)*	3RM1 □ 07 □ AA □ 4

Direct-on-line starter **0**  
 Failsafe direct-on-line starter **1**  
 Screw terminals: **1**  
 Spring-loaded terminals: **2**  
 Mixed connection method: **3**  
 24 V DC Us **0**  
 110 – 230 V AC; 110 V DC Us **1**

\*Operation of resistive loads with maximum 10 A

Note: The 3RM1 motor starters do not have integral short-circuit protection. They can be used very effectively in combination with SIRIUS motor starter protectors in group assemblies, for example.

## Fuseless load feeders up to 15 kW



Standard three-phase motor 4-pole at 400 V AC

[kW]	[A]
0.06	0.20
0.06	0.20
0.09	0.30
0.09	0.30
0.12	0.44
0.18	0.60
0.18	0.60
0.25	0.85
0.37	1.10
0.55	1.50
0.75	1.90
0.75	1.90
1.1	2.70
1.5	3.60
1.5	3.60
2.2	4.90
3	6.50
4	8.50
5.5	11.5
7.5	15.5
7.5	15.5
11	22
11	22
15	29
15	29

### 3RA22 reversing starters

Setting range for thermal overload release [A]	Type of coordination "2" at I <sub>q</sub> = 150 kA at 400 V
0.14 – 0.2	3RA2210-0B □ 15-2 □ □ □ S00
0.18 – 0.25	3RA2210-0C □ 15-2 □ □ □ S00
0.22 – 0.32	3RA2210-0D □ 15-2 □ □ □ S00
0.28 – 0.4	3RA2210-0E □ 15-2 □ □ □ S00
0.35 – 0.5	3RA2210-0F □ 15-2 □ □ □ S00
0.45 – 0.63	3RA2210-0G □ 15-2 □ □ □ S00
0.55 – 0.8	3RA2210-0H □ 15-2 □ □ □ S00
0.7 – 1	3RA2210-0J □ 15-2 □ □ □ S00
0.9 – 1.25	3RA2210-0K □ 15-2 □ □ □ S00
1.1 – 1.6	3RA2210-1A □ 15-2 □ □ □ S00
1.4 – 2	3RA2210-1B □ 15-2 □ □ □ S00
1.8 – 2.5	3RA2210-1C □ 15-2 □ □ □ S00
2.2 – 3.2	3RA2210-1D □ 15-2 □ □ □ S00
2.8 – 4	3RA2210-1E □ 15-2 □ □ □ S00
3.5 – 5	3RA2220-1F □ 24-0 □ □ □ S0
4.5 – 6.3	3RA2220-1G □ 24-0 □ □ □ S0
5.5 – 8	3RA2220-1H □ 24-0 □ □ □ S0
7 – 10	3RA2220-1J □ 24-0 □ □ □ S0
9 – 12.5	3RA2220-1K □ 24-0 □ □ □ S0
10 – 16	3RA2220-4A □ 26-0 □ □ □ S0
13 – 20	3RA2220-4B □ 27-0 □ □ □ S0
16 – 22	3RA2220-4C □ 27-0 □ □ □ S0
18 – 25	3RA2220-4D □ 27-0 □ □ □ S0
23 – 28	3RA2220-4N □ 27-0 □ □ □ S0
27 – 32	3RA2220-4E □ 27-0 □ □ □ S0

- Screw terminals (standard rail mounting) S00: **A**
- Screw terminals (standard rail mounting) S0: **B**
- Spring-loaded terminals (standard rail mounting) S00: **E**
- Spring-loaded terminals (standard rail mounting) S0: **F**
- Screw terminals (busbar adapter): **D**
- Spring-loaded terminals (busbar adapter): **H**
- 24 V DC: **B B 4**
- 230 V AC: **A P 0**



### 3RA62 compact starters

Setting range for thermal overload release [A]	
0.1 – 0.4	3RA6250-□ A □ 3 □
0.32 – 1.25	3RA6250-□ B □ 3 □
1 – 4	3RA6250-□ C □ 3 □
3 – 12	3RA6250-□ D □ 3 □
8 – 32	3RA6250-□ E □ 3 □

- Without terminals: **0 0**
- With screw terminals: **1 2**
- With spring-loaded terminals: **2 2**
- 24 V AC/DC: **B**
- 110 – 240 V AC/DC: **P**



### SIRIUS 3RM1 motor starters

Setting range for thermal overload release [A]	
0.1 – 0.5	3RM1 □ 01 □ AA □ 4
0.4 – 2.0	3RM1 □ 02 □ AA □ 4
1.6 – 7.0 (10 A)*	3RM1 □ 07 □ AA □ 4

- Direct-on-line starter **2**
- Failsafe direct-on-line starter **3**
- Screw terminals: **1**
- Spring-loaded terminals: **2**
- Mixed connection method: **3**
- 24 V DC Us **0**
- 110 – 230 V AC; 110 V DC Us **1**

\*Operation of resistive loads with maximum 10 A

Note: The 3RM1 motor starters do not have integral short-circuit protection. They can be used very effectively in combination with SIRIUS motor starter protectors in group assemblies, for example.

Function modules for IO-Link or AS-i that are mounted on contactors (24 V DC) with communication interface are required for connecting the load feeders to the controller. Depending on the version, these communicate with an IO-Link interface group or any AS-i master. Alternatively, the contactors can be connected to the controller via IO-Link and by means of the 3RB24 overload relay. The 3RR24 current monitoring relays serve to provide optimum current monitoring of the overall system or the driven process.

Typical configuration in the environment of IO-Link

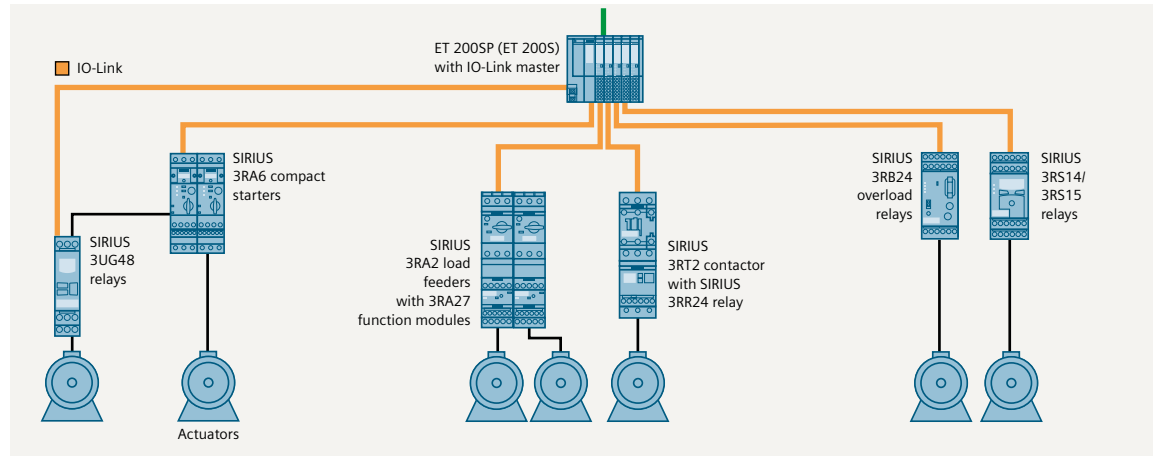

Typical configuration in the environment of AS-Interface

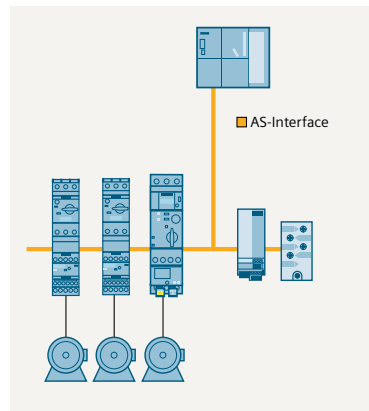

AS-Interface	
Version	Article No.
CP343-2P communications processor for connecting SIMATIC S7-300 to AS-Interface (AS-i Spec.3.0) for up to 62 load feeders	<b>6GK7343-2AH11-0XA0</b>
Front connector 20-pin, with screw-type contacts	<b>6ES7392-1AJ00-0AA0</b>
Front connector 20-pin, with spring-loaded contacts	<b>6ES7392-1BJ00-0AA0</b>
DP/AS-i LINK Advanced, gateway between PROFIBUS DP and AS-Interface	
– Single master for up to 62 load feeders	<b>6GK1415-2BA10</b>
– Double master for up to 124 load feeders	<b>6GK1415-2BA20</b>
AS-Interface power supply unit IP20	
– 120/230 V AC 3 A	<b>3RX9501-0BA00</b>
– 24 V DC 3 A	<b>3RX9501-1BA00</b>
– 120/230 V AC 5 A	<b>3RX9502-0BA00</b>
– 120/230 V AC 8 A	<b>3RX9503-0BA00</b>
Further system components for AS-Interface	<b>See Industry Mall or Catalog IKPI</b>

Three-phase motor 400 V [kW]	Rated operational current contactor [A]
3	7
4	9
5.5	12
7.5	16
5.5	12
7.5	16
11	25
15	32
18.5	38

Contactors S00 with communication interface	
Aux. contacts	Control supply voltage Article No. DC 24 V
1NC	<b>3RT2015-□BB42-0CC0</b>
1NO	<b>3RT2015-□BB41-0CC0</b>
1NC	<b>3RT2016-□BB42-0CC0</b>
1NO	<b>3RT2016-□BB41-0CC0</b>
1NC	<b>3RT2017-□BB42-0CC0</b>
1NO	<b>3RT2017-□BB41-0CC0</b>
1NC	<b>3RT2018-□BB42-0CC0</b>
1NO	<b>3RT2018-□BB41-0CC0</b>

Contactors S0 with communication interface	
Aux. contacts	Control supply voltage Article No. DC 24 V
1NO + 1NC	<b>3RT2024-□BB40-0CC0</b>
1NO + 1NC	<b>3RT2025-□BB40-0CC0</b>
1NO + 1NC	<b>3RT2026-□BB40-0CC0</b>
1NO + 1NC	<b>3RT2027-□BB40-0CC0</b>
1NO + 1NC	<b>3RT2028-□BB40-0CC0</b>

Screw terminals: ①  
 Spring-loaded terminals S00/S0: ②

18.5	40
22	50
30	65
37	80

Contactors S2 with communication interface	
Aux. contacts	Control supply voltage Article No. DC 24 V
1NO + 1NC	<b>3RT2035-□NB30-0CC0</b>
1NO + 1NC	<b>3RT2036-□NB30-0CC0</b>
1NO + 1NC	<b>3RT2037-□NB30-0CC0</b>
1NO + 1NC	<b>3RT2038-□NB30-0CC0</b>

Screw terminals: ①  
 Spring-loaded terminals in auxiliary circuit: ③

37	80
45	95
55	110

Contactors S3 with communication interface	
Aux. contacts	Control supply voltage Article No. DC 24 V
1NO + 1NC	<b>3RT2045-□NB30-0CC0</b>
1NO + 1NC	<b>3RT2046-□NB30-0CC0</b>
1NO + 1NC	<b>3RT2047-□NB30-0CC0</b>

Screw terminals: ①  
 Spring-loaded terminals in auxiliary circuit: ③

# Function modules for mounting on 3RT2 contactors and for connecting to the automation level

## Parallel wiring



**Direct-on-line starter with time-delay relay**

Article No.		
ON-delay	S00/S0 S2/S3 S2/S3	3RA2811- <input type="checkbox"/> CW10 3RA2831- <input type="checkbox"/> DG10 3RA2831- <input type="checkbox"/> DH10
OFF-delay (with aux. voltage)	S00/S0 S2/S3 S2/S3	3RA2812- <input type="checkbox"/> CW10 3RA2832- <input type="checkbox"/> DG10 3RA2832- <input type="checkbox"/> DH10



**Reversing starter kits**

Article No.		
Wiring kits for contactors	S00	3RA2913-2AA <input type="checkbox"/>
Wiring kits for contactors	S0	3RA2923-2AA <input type="checkbox"/>
Wiring kits for contactors	S2	3RA2933-2AA <input type="checkbox"/>
Wiring kits for contactors	S3	3RA2943-2AA <input type="checkbox"/>



**Star-delta (wye-delta) starter<sup>1) 2) 4)</sup>**

Article No.		
Function module		3RA2816-0EW20
Wiring kits for contactors	S00	3RA2913-2BB <input type="checkbox"/>
Wiring kits for contactors	S0	3RA2923-2BB <input type="checkbox"/>
Wiring kits for contactors	S2	3RA2933-2BB <input type="checkbox"/>
Wiring kits for contactors	S3	3RA2943-2BB <input type="checkbox"/>

## IO-Link



**IO-Link connection for direct-on-line starter<sup>1) 2)</sup>**

Article No.	
Function module	3RA2711- <input type="checkbox"/> AA00



**IO-Link connection for reversing starter<sup>1) 2) 3)</sup>**

Article No.		
Function module		3RA2711- <input type="checkbox"/> BA00
Wiring kits for contactors	S00	3RA2913-2AA <input type="checkbox"/>
Wiring kits for contactors	S0	3RA2923-2AA <input type="checkbox"/>
Wiring kits for contactors	S2	3RA2933-2AA <input type="checkbox"/>
Wiring kits for contactors	S3	3RA2943-2AA <input type="checkbox"/>



**IO-Link connection for star-delta (wye-delta) combinations<sup>1) 2) 4)</sup>**

Article No.		
Function module		3RA2711- <input type="checkbox"/> CA00
Wiring kits for contactors	S00	3RA2913-2BB <input type="checkbox"/>
Wiring kits for contactors	S0	3RA2923-2BB <input type="checkbox"/>
Wiring kits for contactors	S2	3RA2933-2BB <input type="checkbox"/>
Wiring kits for contactors	S3	3RA2943-2BB <input type="checkbox"/>

## AS-Interface



**AS-Interface connection for direct-on-line starter<sup>1) 2)</sup>**

Article No.	
Function module	3RA2712- <input type="checkbox"/> AA00



**AS-Interface connection for reversing starter<sup>1) 2) 3)</sup>**

Article No.		
Function module		3RA2712- <input type="checkbox"/> BA00
Wiring kits for contactors	S00	3RA2913-2AA <input type="checkbox"/>
Wiring kits for contactors	S0	3RA2923-2AA <input type="checkbox"/>
Wiring kits for contactors	S2	3RA2933-2AA <input type="checkbox"/>
Wiring kits for contactors	S3	3RA2943-2AA <input type="checkbox"/>



**AS-Interface connection for star-delta (wye-delta) combinations<sup>1) 2) 4)</sup>**

Article No.		
Function module		3RA2712- <input type="checkbox"/> CA00
Wiring kits for contactors	S00	3RA2913-2BB <input type="checkbox"/>
Wiring kits for contactors	S0	3RA2923-2BB <input type="checkbox"/>
Wiring kits for contactors	S2	3RA2933-2BB <input type="checkbox"/>
Wiring kits for contactors	S3	3RA2943-2BB <input type="checkbox"/>

Screw terminals: ①  
Spring-loaded terminals: ②

Screw terminals: ①  
Spring-loaded terminals: ②

Screw terminals: ①  
Spring-loaded terminals: ②

The contactor assemblies represented above can be combined with motor starter protectors, overload relays, and monitoring relays

<sup>1)</sup> The wiring modules for the control circuit are not required    <sup>2)</sup> The contactor with basic module must be implemented as a communication contactor

<sup>3)</sup> Comprising 1 basic module and 1 coupling module    <sup>4)</sup> Comprising 1 basic module and 2 coupling modules

## IO-Link

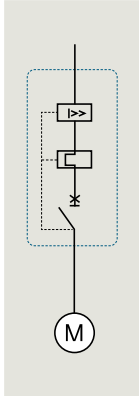

	3RA64 direct-on-line starter	3RA65 reversing starter
Setting range for electronic overload release	CPS <sup>1)</sup>	CPS <sup>1)</sup>
[A]	24 V DC	24 V DC
0.1 – 0.4	3RA6400- □ AB42	3RA6500- □ AB42
0.32 – 1.25	3RA6400- □ BB42	3RA6500- □ BB42
1 – 4	3RA6400- □ CB42	3RA6500- □ CB42
3 – 12	3RA6400- □ DB42	3RA6500- □ DB42
8 – 32	3RA6400- □ EB42	3RA6500- □ EB42

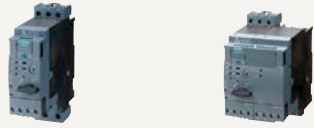

Accessories for compact starter with IO-Link, 3RA27 function modules and 3RB24 overload relays with IO-Link	
Module connector, 14-pole, 8 cm, for 1 space between two contactors	3RA2711-0EE02
Module connector, 14-pole, 21 cm, for diverse space combinations between two contactors	3RA2711-0EE03
Operator panel (incl. enabling module and interface cover)	3RA6935-0A
Connecting cable for operator panel	3RA6933-0A



## AS-Interface

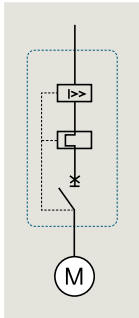

	3RA61 direct-on-line starter	3RA62 reversing starter
Setting range for electronic overload release	CPS <sup>1)</sup>	CPS <sup>1)</sup>
[A]	24 V AC/DC	24 V AC/DC
0.1 – 0.4	3RA6120- □ AB34	3RA6250- □ AB34
0.32 – 1.25	3RA6120- □ BB34	3RA6250- □ BB34
1 – 4	3RA6120- □ CB34	3RA6250- □ CB34
3 – 12	3RA6120- □ DB34	3RA6250- □ DB34
8 – 32	3RA6120- □ EB34	3RA6250- □ EB34



AS-Interface accessories	
AS-i addressing unit	3RK1904-2AB0
AS-Interface mounting module for 3RA6 compact starter (24 V DC)	
Without additional inputs/outputs	3RA6970-3A
With two local inputs	3RA6970-3B
With two free external inputs	3RA6970-3C
With one free external input and one free external output	3RA6970-3D
With two free external outputs	3RA6970-3E
For local control	3RA6970-3F



<sup>1)</sup> CPS: Control and protective switching device, IEC/EN 60947-6-2

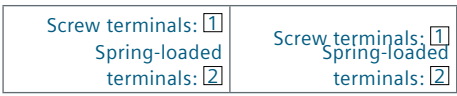

## 3RA68 infeed system (compact starter)

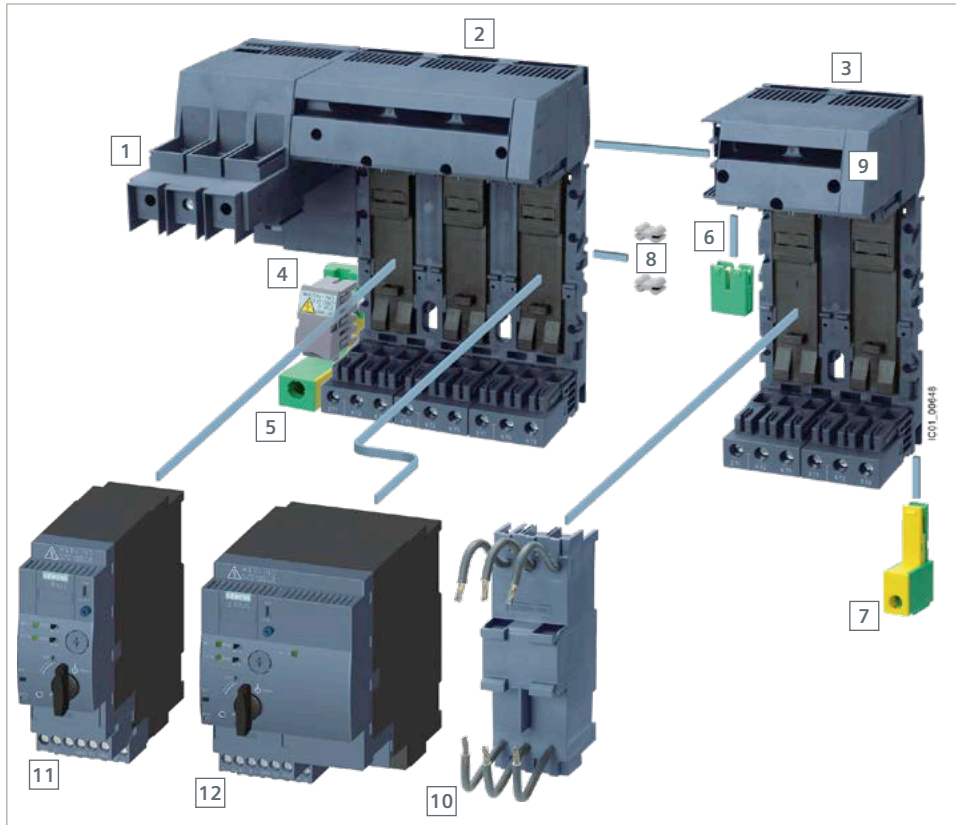

Item 4, 8 and 9 already included in the scope of delivery

Type	Version of terminals	Article No.
<b>1 For busbar mounting (diagram)</b>		
Infeed with screw terminals 25/35 mm <sup>2</sup> left with permanently fitted 3-socket expansion module	Screw terminals up to 63 A	3RA6812-8AB
Infeed with screw terminals 25/35 mm <sup>2</sup> left with permanently fitted 3-socket expansion module	Spring-loaded terminals up to 63 A	3RA6812-8AC
Infeed with screw terminals 50 – 70 mm <sup>2</sup> left with permanently fitted 3-socket expansion module	Screw terminals up to 100 A	3RA6813-8AB
Infeed with screw terminals 50 – 70 mm <sup>2</sup> left with permanently fitted 3-socket expansion module	Spring-loaded terminals up to 100 A	3RA6813-8AC
Terminal covers for infeed w. screw terminals	25/35 mm <sup>2</sup>	3RA6880-2AB
Terminal covers for infeed w. screw terminals	50/70 mm <sup>2</sup>	3RA6880-3AB
Infeed with spring-loaded terminals 25/35 mm <sup>2</sup> left or right up to 63 A		3RA6830-5AC
<b>Expansion modules</b>		
2 3-socket expansion module with 3 slots	Screw terminals	3RA6823-0AB
3 2-socket expansion module with 2 slots	Screw terminals	3RA6822-0AB
2-socket expansion module with 2 slots	Spring-loaded terminals	3RA6822-0AC
3-socket expansion module with 3 slots	Spring-loaded terminals	3RA6823-0AC
<b>4 Expansion plug between 2 expansion modules (already included in the scope of delivery of the expansion modules)</b>		
<b>5 PE infeed</b>		
PE infeed 25/35 mm <sup>2</sup>	Screw terminals	3RA6860-6AB
PE infeed 25/35 mm <sup>2</sup>	Spring-loaded terminals	3RA6860-5AC
<b>6 PE expansion plug</b>		
<b>7 PE tap</b>		
PE tap 6/10 mm <sup>2</sup>	Screw terminals	3RA6870-4AB
PE tap 6/10 mm <sup>2</sup>	Spring-loaded terminals	3RA6870-3AC
<b>8 Connecting wedge (already included in scope of [2] and [3])</b>		
<b>9 Cover cap of the power bus (already included in scope of [1])</b>		
<b>Further accessories</b>		
10 Adapter 45 mm for 3RV motor starter protector with screw terminals		3RA6890-0BA
Expansion plug for SIRIUS 3RV29 infeed system		3RA6890-1AA
Terminal block for integration of 1-, 2- or 3-pole components	Spring-loaded terminals	3RV2917-5D
11 3RA61 compact direct-on-line starter		
12 3RA62 compact reversing starter		



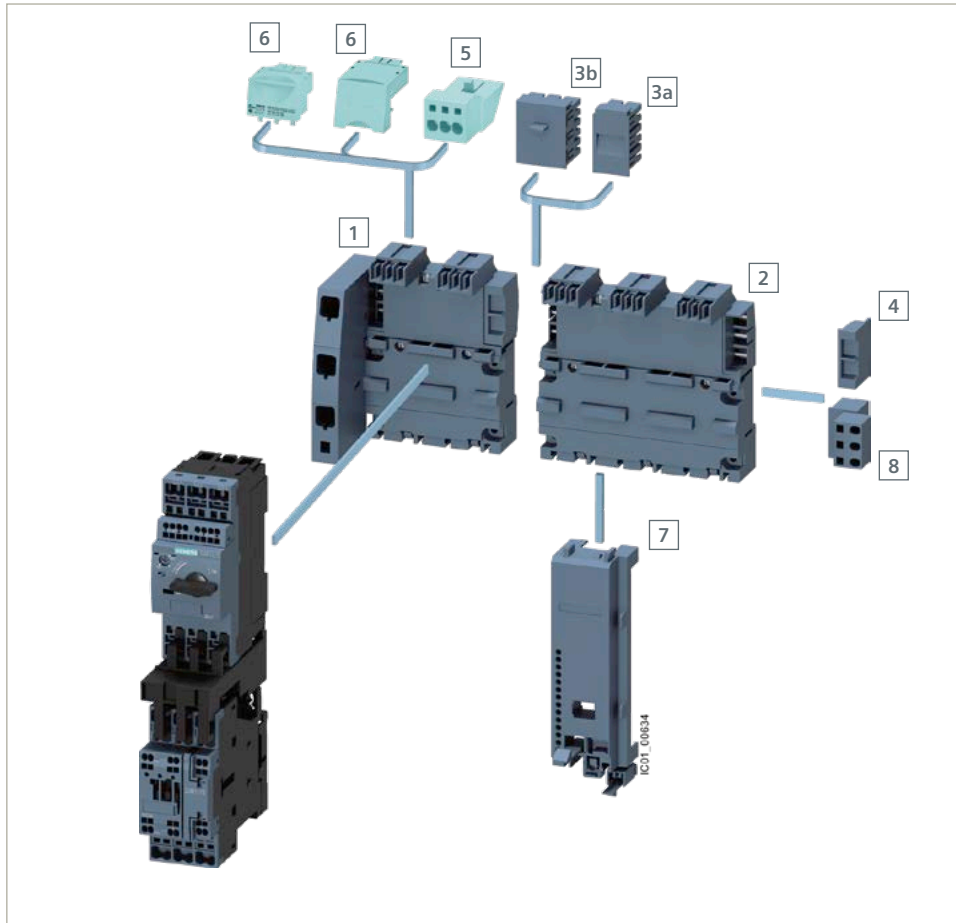

Type	Version	Size for 3RV20, 3RV23 motor starter protectors	Article No.		
<b>3-phase busbars</b>					
1	<b>With infeed on the left</b> incl. 3RV2917-6A end cover	For 2 motor starter protectors	S00, S0	3RV2917-1A	
	<b>With infeed on the right</b> incl. 3RV2917-6A end cover	For 2 motor starter protectors	S00, S0	3RV2917-1E	
	<b>For system expansion</b> incl. 3RV2917-5BA00 expansion plug	For 2 motor starter protectors	S00, S0	3RV2917-4A	
2	<b>For system expansion</b> incl. 3RV2917-5BA00 expansion plug	For 3 motor starter protectors	S00, S0	3RV2917-4B	
<b>Spare parts</b>					
3a	<b>Expansion plug</b>			3RV2917-5BA00	
3b	<b>Broadened expansion plug</b>			3RV2917-5E	
4	<b>End cover</b>			3RV2917-6A	
<b>Plug-in connectors</b>					
5	Terminal block for device infeed	Spring-loaded terminals	1 unit	S00/S0	3RV2917-5FA00
6	For contacting the motor starter protectors	Screw terminals	1 unit	S00	3RV2917-5CA00
			10 un.	S00	3RV2917-5C
		Spring-loaded terminals	1 unit	S00	3RV2917-5AA00
			10 un.	S00	3RV2917-5A
		Screw terminals	1 unit	S0	3RV1927-5AA00
			10 un.	S0	3RV1927-5A
		Spring-loaded terminals	1 unit	S0	3RV2927-5AA00
			10 un.	S0	3RV2927-5A
<b>Accessories</b>					
7	Contactor base for assembling direct-on-line or reversing starters or preassembled 3RA2 load feeders		1 unit	S00	3RV2917-7AA00
			1 unit	S00/S0	3RV2927-7AA00
8	<b>Terminal block for integration of 1-, 2- or 3-pole components</b>				3RV2917-5D
	<b>Mounting rail, 45 mm, for integrating other devices into the system, such as 5SY miniature circuit breakers</b>				3RV1917-7B

## 3-phase busbars /8US busbar adapters for infeed

Type	Size	Article No.			
<b>3-phase busbars</b>					
For infeed to several 3RV2 motor starter protectors (screw terminals) mounted side-by-side on standard rails, with touch protection		Modular spacing 45 mm	Modular spacing 55 mm	Modular spacing 63 mm	Modular spacing 75 mm
For 2 motor starter protectors	S00, S0	3RV1915-1AB	3RV1915-2AB	3RV1915-3AB	–
	S2	–	3RV1935-1A	–	3RV1935-3A
1 For 3 motor starter protectors	S00, S0	3RV1915-1BB	3RV1915-2BB	–	–
	S2	–	3RV1935-1B	–	3RV1935-3B
For 4 motor starter protectors	S00, S0	3RV1915-1CB	3RV1915-2CB	3RV1915-3CB	–
	S2	–	3RV1935-1C	–	3RV1935-3C
For 5 motor starter protectors	S00, S0	3RV1915-1DB	3RV1915-2DB	–	–
<b>3-phase infeed terminals</b>					
2 Connection from above	S00, S0	3RV2925-5AB			
	S2	3RV2935-5A			
Connection from below	S00, S0	3RV2915-5B			
<b>3-phase infeed terminals for constructing type E starters</b>					
Connection from above	S00, S0	3RV2925-5EB			
	S2	3RV2935-5E			
<b>Accessories</b>					
Cover caps for connection tags	S00, S0	3RV1915-6AB			
Touch protection for empty positions	S2	3RV1935-6A			

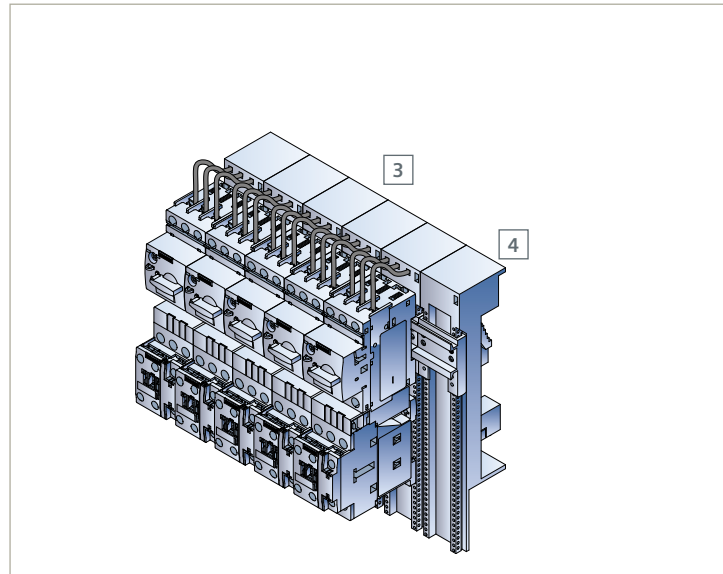
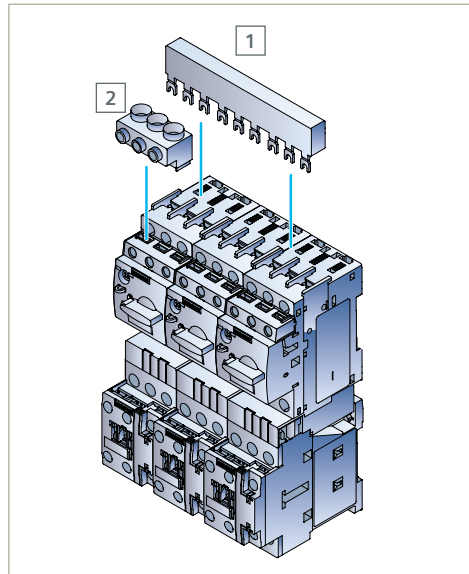

For MSPs, size	Rated operational current [A]	Adapter length [mm]	Adapter width [mm]	Article No.
<b>3 Busbar adapters for 60-mm systems</b>				
<b>For 3RM1 motor starters with fuse module 3RM193 □-□□□□</b>				
22.5 mm	7	200	22.5	8US1216-0AS00 <sup>2)</sup>
<b>For motor starter protectors and load feeders with screw type terminals</b>				
S00, S0	25	200	45	8US1251-5DS10
S0	32	200	45	8US1251-5NS10
S2	80	200	55	8US1261-5MS13
S2	80	260	55	8US1261-6MT10
S2 <sup>1)</sup>	80	260	118	8US1211-6MT10
S3	100	215	72	8US1211-4TR00
<b>For motor starter protectors and load feeders with spring-loaded terminals</b>				
S00, S0	25	200	45	8US1251-5DS11
S00, S0	25	260	45	8US1251-5DT11
S0	32	260	45	8US1251-5NT11

<sup>1)</sup> For the assembly of feeders for reversing starters comprising a motor starter protector and two contactors

<sup>2)</sup> Adapter for 8US1616-0AK02 compact busbar system

<b>Accessories</b>				
4 Device holder for lateral mounting on busbar adapters	200	45	8US1250-5AS10	
	260	45	8US1250-5AT10	
Side module for widening busbar adapters	200	9	8US1998-2BJ10	
Spacer for fixing the feeder onto the busbar adapter			8US1998-1BA10	
Vibration and shock kit for increased vibration and shock loads	S00/S0		8US1998-1CA10	
	S2		8US1998-1DA10	

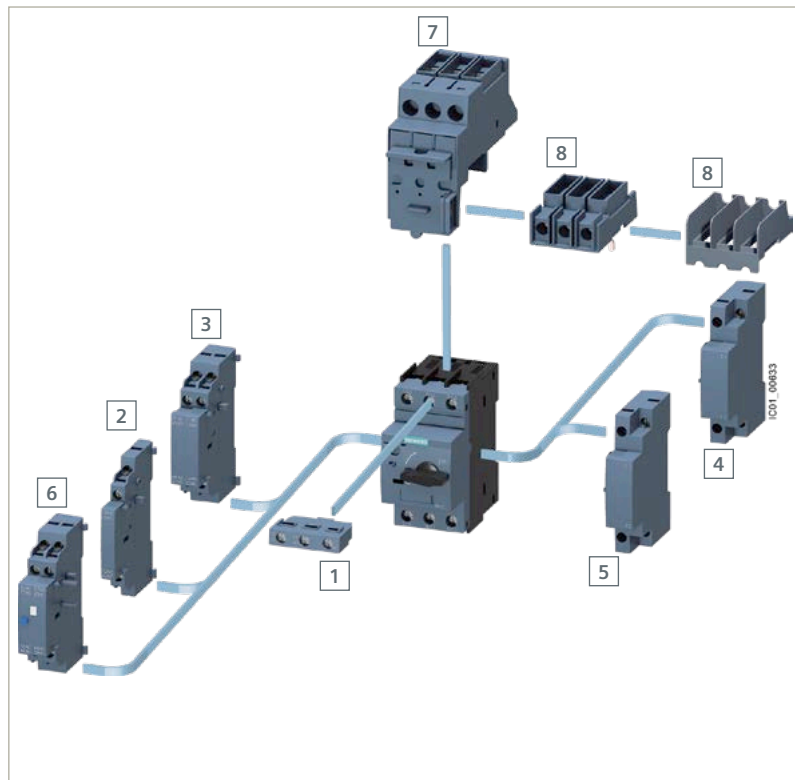

Type	Version	Article No. screw terminals	Article No. spring-loaded terminals
<b>Accessories for 3RV motor starter protectors sizes S00, S0, S2</b>			
<b>Auxiliary and signaling switches</b>			
1 Transverse auxiliary switch	1CO	3RV2901-1D	–
	1NO + 1NC	3RV2901-1E	3RV2901-2E
	2NO	3RV2901-1F	3RV2901-2F
1 Solid-state-compatible auxiliary switch	1CO	3RV2901-1G	–
	1NO + 1NC	3RV2901-1A	3RV2901-2A
	2NO	3RV2901-1B	3RV2901-2B
2 Lateral auxiliary switch with 2 contacts	2NC	3RV2901-1C	3RV2901-2C
	2NO + 2NC	3RV2901-1J	–
3 Lateral auxiliary switch with 4 contacts			
6 Signaling switch		3RV2921-1M	3RV2921-2M
<b>Auxiliary releases</b>			
4 Shunt release <sup>1)</sup>	20 – 70 V AC/DC	3RV2902-1DB0	3RV2902-2DB0
	210 – 240 V AC	3RV2902-1DPO	3RV2902-2DPO
5 Undervoltage release <sup>1)</sup>	230 V AC	3RV2902-1AP0	3RV2902-2AP0
	400 V AC	3RV2902-1AV0	3RV2902-2AV0
5 Undervoltage release with leading auxiliary contacts	230 V AC	3RV2922-1CP0	3RV2922-2CP0
	400 V AC	3RV2922-1CV0	3RV2922-2CV0
	415 V AC	3RV2922-1CV1	3RV2922-2CV1
<b>Isolator module and terminal blocks</b>			
7 Isolator module	S00, S0	3RV2928-1A	–
	S2	3RV2938-1A	–
8 Terminal block type E for increased clearances and creepage distances	S00, S0	3RV2928-1H	–
8 Terminal block type E for S3	S3	3RT2946-4GA07	–
8 Phase barriers f. incr. clearances/creepage distances	S00, S0	3RV2928-1K	–
	S2	3RV2938-1K	–

Type	Version	Article No.
<b>Door-coupling rotary operating mechanisms</b>		
Door-coupling rotary operating mech. (black) with extension shaft <sup>2)</sup>	130 mm	3RV2926-0B
Door-coupling rotary operating mech. (black) with extension shaft	330 mm	3RV2926-0K
EMERGENCY-STOP door-cpl. rot. oper. mech. (red/yellow) w. ext. shaft <sup>2)</sup>	130 mm	3RV2926-0C
EMERGENCY-STOP door-cpl. rot. oper. mech. (red/yellow) w. ext. shaft	330 mm	3RV2926-0L
<b>Molded-plastic enclosures for surface mounting</b>		
For motor starter protector (+ lateral auxiliary switch) S00, S0	54 mm	3RV1923-1CA00
For motor starter protector (+ lateral aux. switch + auxiliary release) S00, S0	72 mm	3RV1923-1DA00
For motor starter protector (+ lateral auxiliary switch + auxiliary release) S2	82 mm	3RV1933-1DA00
Molded-plastic enclosure for surface mounting with EMERGENCY-STOP door-cpl. rot. op. mech. f. MSP (+ lateral aux. switch) S00, S0	54 mm	3RV1923-1FA00
Molded-plastic enclosure for surface mounting w. EMERGENCY-STOP door-cpl. rot. op. mech. f. MSP (+ lateral aux. switch + aux. release) S00, S0	72 mm	3RV1923-1GA00
Molded-plastic enclosure for surface mounting w. EMERGENCY-STOP door-cpl. rot. oper. mech. f. MSP (+ lateral aux. switch + aux. release) S2	82 mm	3RV1933-1GA00

<sup>1)</sup> Other versions on request <sup>2)</sup> The operating mechanism is also suitable for 3RA6 compact starters

## Accessories for 3RT201 contactors (S00)

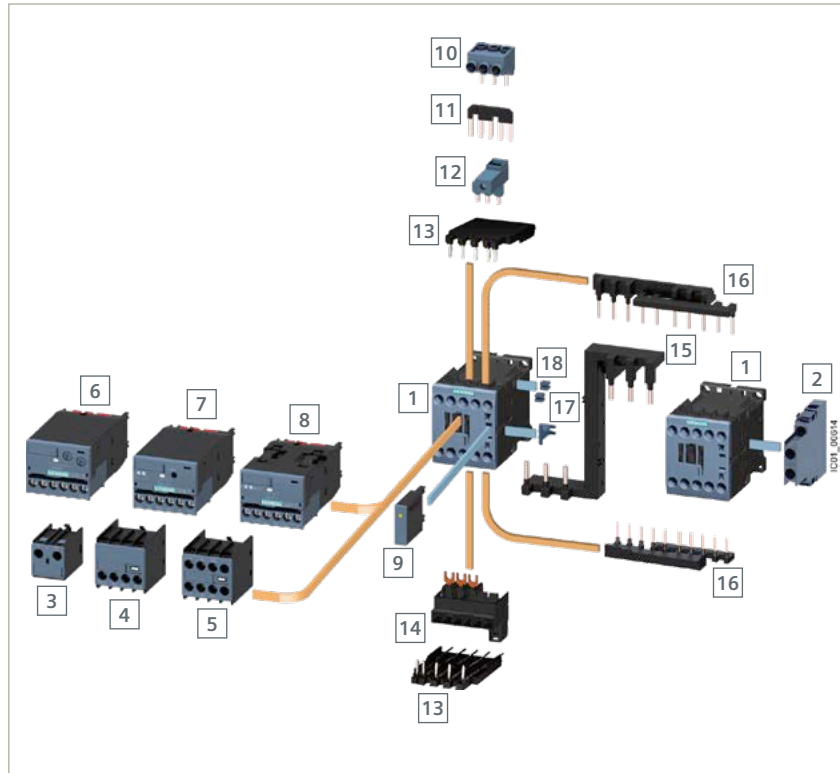

Fitting of auxiliary switches on the front for		Version	Article No. screw terminals	Article No. spring-loaded terminals
1	3RT2 contactors	Standard		
	Laterally mountable auxiliary switch blocks	2NO	3RH2911-1DA20	3RH2911-2DA20
		1NO + 1NC	3RH2911-1DA11	3RH2911-2DA11
		2NC	3RH2911-1DA02	3RH2911-2DA02
2	Solid-state-compatible auxiliary switch block laterally mountable, right	1NO + 1NC	–	3RH2911-2DE11
	Solder pin adapter for contactors with 4-pole auxiliary switch block	For 4 contactors (package)	3RT1916-4KA2	–
3	1-pole auxiliary switch block, cable entry from above	1NO	3RH2911-1AA10	–
	1-pole auxiliary switch block, cable entry from below	1NO	3RH2911-1BA10	–
		1NC	3RH2911-1BA01	–
4	2-pole auxiliary switch block, cable entry from above	1NO + 1NC	3RH2911-1LA11	–
	2-pole auxiliary switch block, cable entry from below	2NO	3RH2911-1LA20	–
		1NO + 1NC	3RH2911-1MA11	–
		2NO	3RH2911-1MA20	–
5	1- to 4-pole auxiliary switch block	1NC	3RH2911-1HA01	3RH2911-2HA01
		2NC	3RH2911-1HA02	3RH2911-2HA02
		1NO + 1NC	3RH2911-1HA11	3RH2911-2HA11
		2NO + 2NC	3RH2911-1HA22	3RH2911-2HA22
		1NO	3RH2911-1HA10	3RH2911-2HA10
		2NO	3RH2911-1HA20	3RH2911-2HA20
	Solid-state-compatible auxiliary switch blocks 2-pole	1NO + 1NC	3RH2911-1NF11	3RH2911-2NF11
		2NO	3RH2911-1NF20	3RH2911-2NF20
		2NC	3RH2911-1NF02	3RH2911-2NF02
[6] [7] [8] Function modules for mounting on contactors and for connecting to the automation level				
	Surge suppressor, e.g. varistor			
9	Without LED	127 – 240 V AC	3RT2916-1BD00	3RT2916-1BD00
	With LED	127 – 240 V AC	3RT2916-1JL00	3RT2916-1JL00
10	3-phase infeed terminal	Conductor cross section: 6 mm	3RA2913-3K	–
11	Neutral bridge, 3-pole	–	3RT1916-4BA31	3RT2916-4BA32
12	Parallel connector, 3-pole	For main circuits	3RT1916-4BB31	–
13	Solder pin adapter for contactors	For 4 contactors (package)	3RT1916-4KA1	–
14	Terminal module for contactor with screw terminals	Adapter	3RT1916-4RD01	–
		Plug	3RT1900-4RE01	–
15	Safety main circuit connector	–	3RA2916-1A	–
16–18	Wiring kit	–	3RA2913-2AA1	3RA2913-2AA2

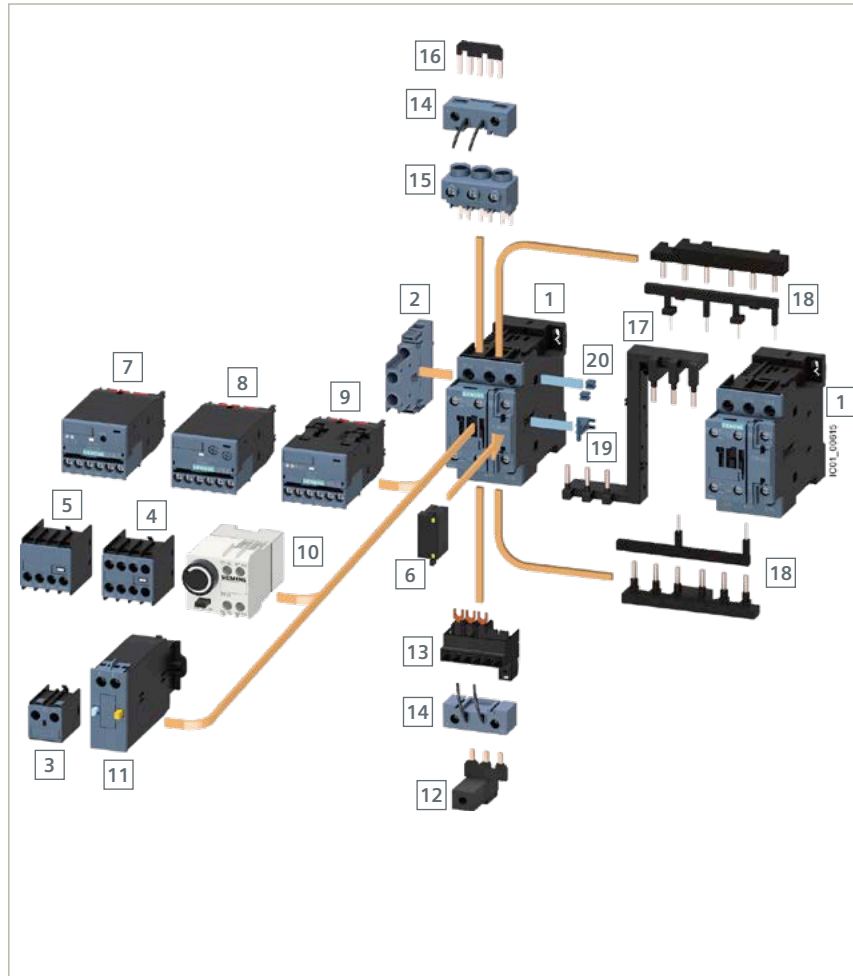

Fitting of auxiliary switches on the front for		Version	Article No. screw terminals	Article No. spring-loaded terminals	
1	3RT2 contactors	Standard			
2	Laterally mountable auxiliary switch blocks	2NO	3RH2921-1DA20	3RH2921-2DA20	
		1NO + 1NC	3RH2921-1DA11	3RH2921-2DA11	
		2NC	3RH2921-1DA02	3RH2921-2DA02	
	Solid-state-compatible auxiliary switch block, laterally mountable	1NO + 1NC	–	3RH2921-2DE11	
3	1-pole auxiliary switch block, cable entry from above	1NO	3RH2911-1AA10	–	
		1NC	3RH2911-1AA01	–	
	1-pole auxiliary switch block, cable entry from below	1NO	3RH2911-1BA10	–	
		1NC	3RH2911-1BA01	–	
4	1- to 4-pole auxiliary switch block	1NC	3RH2911-1HA01	3RH2911-2HA01	
		2NC	3RH2911-1HA02	3RH2911-2HA02	
		1NO + 1NC	3RH2911-1HA11	3RH2911-2HA11	
		2NO + 2NC	3RH2911-1HA22	3RH2911-2HA22	
			1NO	3RH2911-1HA10	3RH2911-2HA10
			2NO	3RH2911-1HA20	3RH2911-2HA20
	Solid-state-compatible auxiliary switch blocks 2-pole	1NO + 1NC	3RH2911-1NF11	3RH2911-2NF11	
		2NO	3RH2911-1NF20	3RH2911-2NF20	
2NC		3RH2911-1NF02	3RH2911-2NF02		
5	2-pole auxiliary switch block, cable entry from above	1NO + 1NC	3RH2911-1LA11	–	
		2NO	3RH2911-1LA20	–	
	2-pole auxiliary switch block, cable entry from below	1NO + 1NC	3RH2911-1MA11		
		2NO	3RH2911-1MA20		
6	Surge suppressor, e.g. varistor	Without LED	3RT2926-1BD00	3RT2926-1BD00	
		With LED	3RT2926-1JL00	3RT2926-1JL00	
7	8	9	Function modules for mounting on contactors and for connecting to the automation level		
10	Pneumatic delay block 1NO + 1NC	ON-delay, 0.1 – 30 s	3RT2926-2PA01	–	
		ON-delay, 1 – 60 s	3RT2926-2PA11	–	
		OFF-delay, 0.1 – 30 s	3RT2926-2PRO1	–	
		OFF-delay, 1 – 60 s	3RT2926-2PR11	–	
11	Mechanical latch	230 V AC/DC	3RT2926-3AP31	3RT2926-3AP31	
12	Parallel connector, 3-pole	For main circuits	3RT2926-4BB31	–	
13	Terminal module for contactor with screw terminals	Adapter	3RT1926-4RD01	–	
		Plug	3RT1900-4RE01		
14	Coil terminal module	Connection from above	3RT2926-4RA11	3RT2926-4RA12	
		Connection from below	3RT2926-4RB11	3RT2926-4RB12	
		Connection diagonally	3RT2926-4RC11	3RT2926-4RC12	
15	3-phase infeed terminal	–	3RV2925-5AB	–	
16	Neutral bridge, 3-pole	–	3RT1926-4BA31	3RT2926-4BA32	
17	Safety main circuit connector	For series switching of 2 contactors	3RA2926-1A	–	
18–20	Wiring kit	For reversing combinations	3RA2923-2AA1	3RA2923-2AA2	

## Accessories for 3RT203 contactors (S2)

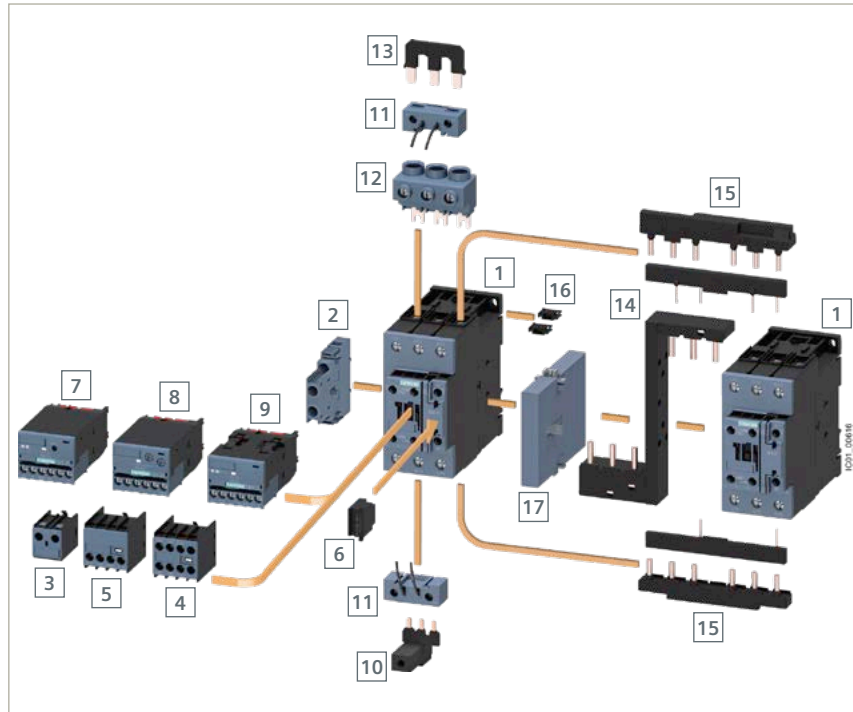

Fitting of auxiliary switches on the front for		Version	Article No. screw terminals	Article No. spring-loaded terminals
1	3RT2 contactors	Standard		
2	Laterally mountable auxiliary switch blocks	2NO	3RH2921-1DA20	3RH2921-2DA20
		1NO + 1NC	3RH2921-1DA11	3RH2921-2DA11
		2NC	3RH2921-1DA02	3RH2921-2DA02
	Solid-state-compatible auxiliary switch block, laterally mountable	1NO + 1NC	–	3RH2921-2DE11
3	1-pole auxiliary switch block, cable entry from above	1NO	3RH2911-1AA10	–
		1NC	3RH2911-1AA01	–
		1NO	3RH2911-1BA10	–
	1-pole auxiliary switch block, cable entry from below	1NC	3RH2911-1BA01	–
4	1- to 4-pole auxiliary switch block	1NC	3RH2911-1HA01	3RH2911-2HA01
		2NC	3RH2911-1HA02	3RH2911-2HA02
		1NO + 1NC	3RH2911-1HA11	3RH2911-2HA11
		2NO + 2NC	3RH2911-1HA22	3RH2911-2HA22
		1NO	3RH2911-1HA10	3RH2911-2HA10
		2NO	3RH2911-1HA20	3RH2911-2HA20
	Solid-state-compatible auxiliary switch 2-pole	1NO + 1NC	3RH2911-1NF11	3RH2911-2NF11
		2NO	3RH2911-1NF20	3RH2911-2NF20
		2NC	3RH2911-1NF02	3RH2911-2NF02
5	2-pole auxiliary switch block, cable entry from above	1NO + 1NC	3RH2911-1LA11	–
		2NO	3RH2911-1LA20	–
	2-pole auxiliary switch block, cable entry from below	1NO + 1NC	3RH2911-1MA11	
		2NO	3RH2911-1MA20	
6	Surge suppressor, e.g. varistor (230 V AC)	Without LED		
		127 – 240 V AC	3RT2936-1BD00	3RT2936-1BD00
		With LED	127 – 240 V AC	3RT2936-1JL00
7	8	9	Function modules for mounting on contactors and for connecting to the automation level	
10	Parallel connector, 3-pole	For main circuits	3RT1936-4BB31	–
11	Coil terminal module	Connection from above	3RT2926-4RA11	–
		Connection from below	3RT2926-4RB11	–
		Connection diagonally	3RT2926-4RC11	–
12	3-phase infeed terminal	–	3RV2935-5A	–
13	Neutral bridge, 3-pole	–	3RT1936-4BA31	–
14	Safety main circuit connector	For series switching of 2 contactors	3RA2936-1A	–
15	Wiring kit	For reversing combinations	3RA2933-2AA1	–
16	Mechanical interlock	–	3RA2934-2B	3RA2934-2B



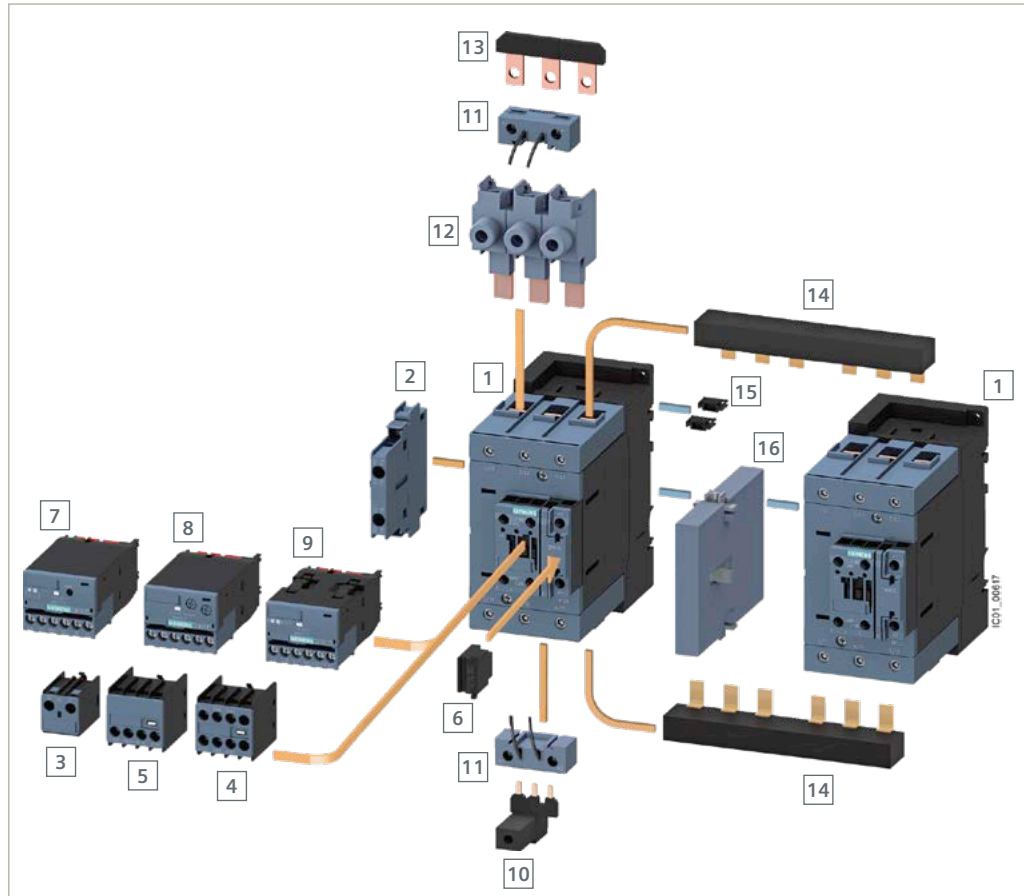

Fitting of auxiliary switches on the front for	Version	Article No. screw terminals	Article No. spring-loaded terminals
<b>1 3RT2 contactors</b>	<b>Standard</b>		
2 Laterally mountable auxiliary switch blocks	2NO	3RH2921-1DA20	3RH2921-2DA20
	1NO + 1NC	3RH2921-1DA11	3RH2921-2DA11
	2NC	3RH2921-1DA02	3RH2921-2DA02
2 Solid-state-compatible auxiliary switch block, laterally mountable	1NO + 1NC	–	3RH2921-2DE11
3 1-pole auxiliary switch block, cable entry from above	1NO	3RH2911-1AA10	–
	1NC	3RH2911-1AA01	–
3 1-pole auxiliary switch block, cable entry from below	1NO	3RH2911-1BA10	–
	1NC	3RH2911-1BA01	–
4 1- to 4-pole auxiliary switch block	1NC	3RH2911-1HA01	3RH2911-2HA01
	2NC	3RH2911-1HA02	3RH2911-2HA02
	1NO + 1NC	3RH2911-1HA11	3RH2911-2HA11
	2NO + 2NC	3RH2911-1HA22	3RH2911-2HA22
	1NO	3RH2911-1HA10	3RH2911-2HA10
	2NO	3RH2911-1HA20	3RH2911-2HA20
4 Solid-state-compatible auxiliary switch blocks, 2-pole	1NO + 1NC	3RH2911-1NF11	3RH2911-2NF11
	2NO	3RH2911-1NF20	3RH2911-2NF20
	2NC	3RH2911-1NF02	3RH2911-2NF02
5 2-pole auxiliary switch block, cable entry from above	1NO + 1NC	3RH2911-1LA11	–
	2NO	3RH2911-1LA20	–
	1NO + 1NC	3RH2911-1MA11	–
5 2-pole auxiliary switch block, cable entry from above	2NO	3RH2911-1MA20	–
6 Surge suppressor, e.g. varistor (230 V AC)	Without LED	127 – 240 V AC	3RT2936-1BD00
	With LED	127 – 240 V AC	3RT2936-1JL00
<b>7 8 9</b> Function modules for mounting on contactors and for connecting to the automation level			
10 Parallel connector, 3-pole	For main circuits	3RT1946-4BB31	–
11 Coil terminal module	Connection from above	3RT2926-4RA11	–
	Connection from below	3RT2926-4RB11	–
	Connection diagonally	3RT2926-4RC11	–
12 1-phase infeed terminal (3 units)		3RA2943-3L	–
13 Neutral bridge, 3-pole		3RT1946-4BA31	–
14 Wiring modules	For reversing combinations	3RA2943-2AA1	–
15 Mechanical interlock		3RA2934-2B	3RA2934-2B



## Accessories for 3RT1 contactors (S6 – S12)

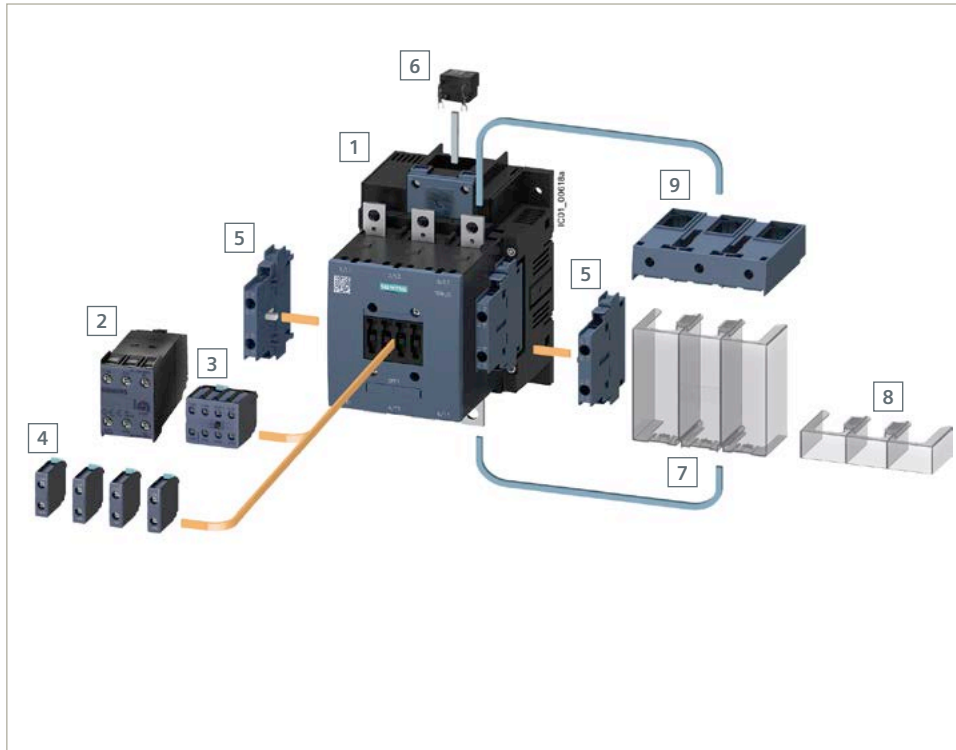

Type	Version	Article No.	
1 3RT1 contactors	Standard		
2 2-pole auxiliary switch block, lateral – ON-delay, 200 – 240 V AC – OFF-delay, 200 – 240 V AC	1NO + 1NC		
	0.5 ... 10 s	3RT1926-2ED21	
	0.5 ... 10 s	3RT1926-2FL21	
3 4-pole auxiliary switch block (on front, screw terminals)	2NO + 2NC	3RH1921-1XA22-0MA0	
4 1-pole auxiliary switch block (on front, screw terminals)	1NC	3RH1921-1CA01	
	1NO	3RH1921-1CA10	
5 2-pole auxiliary switch block (on side, screw terminals) acc. to EN 50012 acc. to EN 50005	1NO + 1NC	3RH1921-1JA11	
	1NO + 1NC	3RH1921-1KA11	
	2NC	3RH1921-1KA02	
	2NO	3RH1921-1KA20	
6 Surge suppressor (RC element), 127 ... 240 V AC (screw terminals)	For S6 – S12	3RT1956-1CD00	
7 Terminal cover for cable lug and busbar connections	For S6	3RT1956-4EA1	
	For S10/S12	3RT1966-4EA1	
8 Terminal cover for box terminals	For S6	3RT1956-4EA2	
	For S10/S12	3RT1966-4EA2	
<b>Terminal cover for box terminals</b>			
9	For round and ribbon cable conductors up to 70 mm <sup>2</sup>	S6	3RT1955-4G
	For round and ribbon cable conductors up to 120 mm <sup>2</sup>	S6	3RT1956-4G
	For round and ribbon cable conductors up to 240 mm <sup>2</sup>	S10/S12	3RT1966-4G

## Operating mechanism types

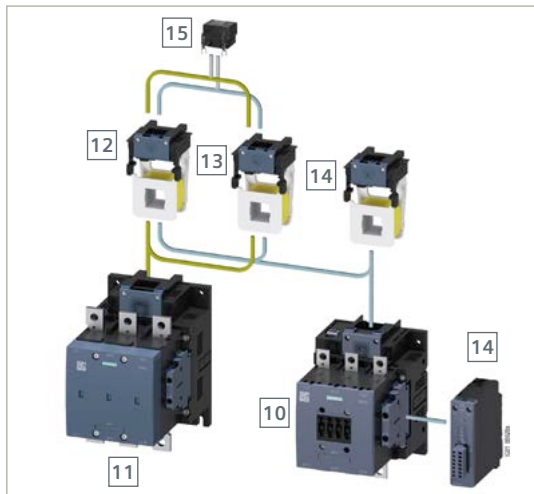

10	3RT10 and 3RT14 air-break contactor, sizes S6, S10 and S12
11	3RT12 vacuum contactor, sizes S10 and S12
12	Withdrawable coils for contactors with 3RT1...-A.. conventional op. mech.
13	Withdrawable coils for contactors with 3RT1...-N.. electronic op. mech.
14	Withdrawable coils and lateral mounting module (snap-on) for 3RT1...-P.. contactors w. el. oper. mech. and remaining lifetime signal
15	RC element, 127 – 240 V AC

Size	Three-phase motor 400 V	Contactor without coil	Withdrawable coil for op. mech.	
			Conventional	Electronic
			Control supply voltage	
			220 – 240 V AC/DC	200 – 277 V AC/DC
		Article No.	Article No.	Article No.
S6	55	3RT1054-1LA06	3RT1955-5AP31	3RT1955-5NP31
	75	3RT1055-6LA06		
	90	3RT1056-6LA06		
S10	110	3RT1064-6LA06	3RT1965-5AP31	3RT1965-5NP31
	132	3RT1065-6LA06		
	160	3RT1066-6LA06		
S12	200	3RT1075-6LA06	3RT1975-5AP31	3RT1975-5NP31
	250	3RT1076-6LA06		
		11	12	13

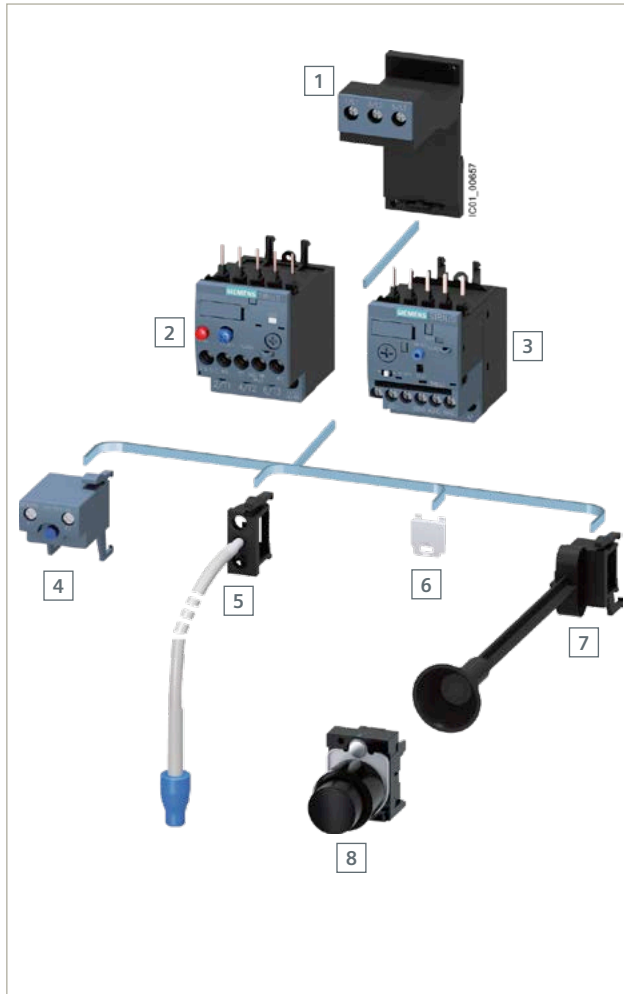

Version	For size	Article No.
<b>Terminal supports for stand-alone installation</b>		
1	Screw fastening and snap-on mounting onto TH 35 standard mounting rail	S00 3RU2916-3A □ 01
	Screw fastening and snap-on mounting onto TH 35 standard mounting rail	S0 3RU2926-3A □ 01
	Screw fastening and snap-on mounting onto TH 35 standard mounting rail	S2 3RU2936-3AA01
	Screw fastening and snap-on mounting onto TH 35 standard mounting rail	S3 3RU2946-3AA01
<b>Mechanical RESET comprising:</b>		
4	24 – 30 V AC/DC	S00 – S3 3RU1900-2AB71
	110 – 127 V AC/DC	S00 – S3 3RU1900-2AF71
	220 – 250 V AC/DC	S00 – S3 3RU1900-2AM71
<b>Cable releases with holders for RESET for drill holes Ø 6.5 mm in the control panel</b>		
5	Length 400 mm	S00 – S3 3RU2900-1B
	Length 400 mm	S00 – S3 3RB3980-0B
	Length 600 mm	S00 – S3 3RU2900-1C
	Length 600 mm	S00 – S3 3RB3980-0C
<b>Sealable cover for 3RB3, 3RU2, 3RR2, transparent</b>		
6	For covering the setting knobs	S00 – S3 3RV2908-0P
	For covering the setting knobs	S00 – S3 3RB3984-0
	For covering the setting knobs	S00 – S3 3RR2940
<b>Modules for electrical remote reset</b>		
7	Resetting plungers, holders and formers	S00 – S3 3RU2900-1A
	Resetting plungers, holders and formers	S00 – S3 3RB3980-0A
8	Push buttons with extended stroke (12 mm), IP65, Ø 22 mm	S00 – S3 3SU1200-0FB10-0AA0
	Extension plungers for compensation of the distance between a push button and the unlatching button of the relay	S00 – S3 3SU1900-0KG10-0AA0



Can be combined with the following overload and current monitoring relays				
2	3RU2	3	3RB3	3RR2
	■		■	■
	■		■	■
	■		■	■
	■		■	■
	■			
	■			
	■		■	
	■		■	
	■			■
	■		■	
	■		■	
	■		■	

Screw terminals:  A  
Spring-loaded terminals:  C

## Accessories for 3RB20/21 electronic overload relays (S6 – S12)

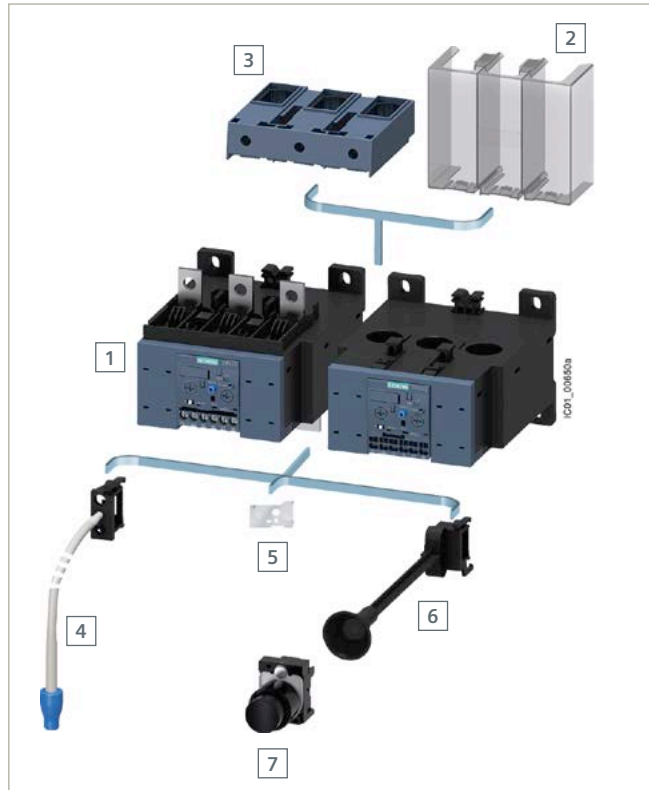

Version	For size	Article No.
<b>1 3RB20/21 electronic overload relays</b>		
<b>Terminal covers for 3RB20/21</b>		
Cover for cable terminal lugs and busbar connections	S6	3RT1956-4EA1
	S10/S12	3RT1966-4EA1
Cover for box terminals	S6	3RT1956-4EA2
	S10/S12	3RT1966-4EA2
	Cover for screw terminals between contactor and overload relay without box terminal (1 unit required per combination)	S6
S10/S12	3RT1966-4EA3	
<b>Box terminal block</b>		
For round and ribbon cable conductors up to 70 mm <sup>2</sup>	S6	3RT1955-4G
For round and ribbon cable conductors up to 120 mm <sup>2</sup>	S6	3RT1956-4G
For round and ribbon cable conductors up to 240 mm <sup>2</sup>	S10/S12	3RT1966-4G
<b>Cable releases with holders for RESET and 3RB20/21</b> for holes Ø 6.5 mm in the control panel, max. control panel thickness 8 mm		
Length 400 mm	S6 – S12	3RB3980-0B
Length 600 mm		3RB3980-0C
<b>5 Sealable cover for 3RB20/21, transparent</b>		
For covering the setting knobs	S6 – S12	3RB3984-0
<b>Mechanical RESET and 3RB20/21 comprising:</b>		
<b>6 Resetting plungers, holders and formers</b>		
Push buttons with extended stroke (12 mm), IP65, Ø 22 mm	S6 – S12	3SU1200-0FB10-0AA0
<b>7 Extension plungers for compensation of the distance between a push button and the unlatching button of the relay</b>		
	S6 – S12	3SU1900-0KG10-0AA0

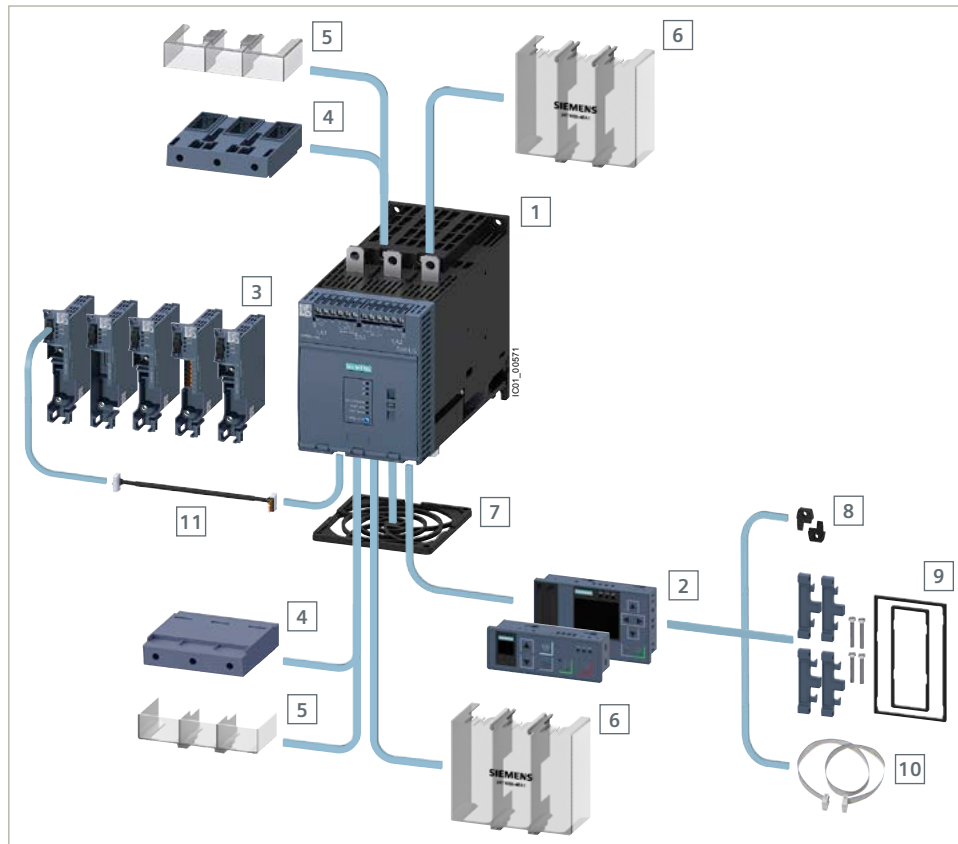

Type	Manufacturer's article number of the soft starter	Version	Article No.	
1	3RW50 soft starters	Standard		
<b>HMI modules</b>				
2	HMI module	3RW50	High-Feature Standard	3RW5980-0HF00 3RW5980-0HS00
<b>Communication modules</b>				
3	Communication module	3RW50	PROFINET standard PROFIBUS EtherNet/IP Modbus RTU Modbus TCP	3RW5980-0CS00 3RW5980-0CP00 3RW5980-0CE00 3RW5980-0CR00 3RW5980-0CT00
<b>Box terminal blocks</b>				
4	Box terminal block for round conductors and flat cables	3RW505 (2x)	Up to 70 mm <sup>2</sup> Up to 120 mm <sup>2</sup>	3RT1955-4G 3RT1956-4G
		3RW507 (2x)	Up to 240 mm <sup>2</sup> (with control wire tap)	3RT1966-4G
<b>Terminal covers</b>				
5	Terminal covers for box terminals	3RW505 (2x) 3RW507 (2x)	–	3RT1956-4EA2 3RT1966-4EA2
6	Cover for cable lug and bar connection	3RW505 (2x) 3RW507 (2x)	–	3RT1956-4EA1 3RT1966-4EA1
<b>Fan covers</b>				
7	Fan cover	3RW50 (1x)	–	3RW5985-0FC00
<b>Push-in lugs</b>				
8	Push-in lug for wall mounting	–	Two lugs are required per device	3ZY1311-0AA00
<b>Mounting kits</b>				
9	IP65 door mounting kit for HMI modules	3RW50	IP65	3RW5980-0HD00
<b>Connecting cables</b>				
10	HMI connecting cable	3RW50	5 m, round	3RW5980-0HC60
			2.5 m, round	3UF7933-0BA00-0
			1.0 m, round	3UF7937-0BA00-0
			0.5 m, round	3UF7932-0BA00-0
11	COM connecting cable for mounting laterally on the device	3RW50	0.3 m	3RW5900-0CC00



**Published by  
Siemens AG**

Smart Infrastructure  
Werner-von-Siemens-Str. 48–50  
92224 Amberg, Germany

**For the U.S. published by  
Siemens Industry Inc.**

100 Technology Drive  
Alpharetta, GA 30005  
United States

Article No.: SICP-T10039-00-7600  
Dispo 27601  
WS 02203.0  
Printed in Germany  
© Siemens 2020

Subject to changes and errors. The information given in this document only contains general descriptions and/or performance features which may not always specifically reflect those described, or which may undergo modification in the course of further development of the products. The requested performance features are binding only when they are expressly agreed upon in the concluded contract.

All product designations may be trademarks or product names of Siemens AG or other companies whose use by third parties for their own purposes could violate the rights of the owners.

**You can find  
more infor-  
mation with  
the QR code**

